

Solid State Relays from 5 to 125 A

77
SERIES



Industrial
motors



Industrial
furnaces
and ovens



Lighting control
in corridors (for
hotels, offices
and hospitals)



Bottling plant



Labelling
machines



Packaging
machines

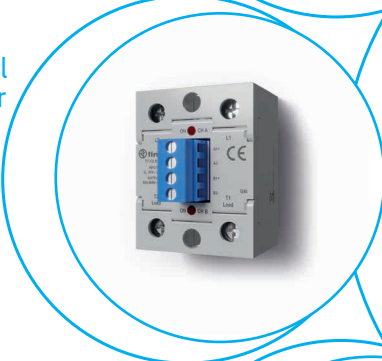

5 A modular SSR, 1 NO AC output

- 17.5 mm housing
- 60 to 240 V AC output (with back to back SCR)
- 5 kV (1.2/50 µs) insulation between Input and Output
- Zero-crossing and random switch-on versions available
- High switching speed
- High endurance
- Silent switching
- Spark and bounce-free switching
- Low control power
- 3-phase general purpose
- 35 mm rail (EN 60715) mount

77.01
Box clamp



* See L77-8 diagram page 18
** See L77-1 and L77-2 diagrams page 17

For outline drawing see page 24

Output specification

Output configuration	1 NO (SPST-NO)		1 NO (SPST-NO)	
Rated current I _N /Max. peak current* (10 ms)	A	5/300*	A	5/300*
Rated voltage	V AC (50/60 Hz)	230	V AC (50/60 Hz)	230
Switching voltage range	V AC (50/60 Hz)	48...265	V AC (50/60 Hz)	48...265
Repetitive peak off-state voltage	V _{pk}	800	V _{pk}	800
Rated load AC7a (cos φ = 0.8)	A	5	A	5
Rated load AC15	A	5	A	3
Single phase motor rating (230 V AC)	kW	—	kW	0.1
Nominal lamp rating:				
230 V incandescent/halogen W		1000		800
fluorescent tubes with electronic ballast W		1000		800
fluorescent tubes with electromagnetic ballast W		1000		800
CFL W		800		400
230 V LED W		800		400
LV halogen or LED with electronic ballast W		800		400
LV halogen or LED with electromagnetic ballast W		1000		800
Minimum switching current @ 230 V	mA	100	mA	100
Typical "OFF-state" leakage current @ 230 V	mA	0.5	mA	3.5
Max "ON-state" voltage drop @ 25 °C and 5 A/100 mA	V	0.85/1.5	V	0.85/1.5
Power loss @ 5 A	W	4	W	4

Input specification

Nominal voltage (U _N)	V AC (50/60 Hz)	—	230	—	230
	V DC	6...24	—	6...24	—
Rated power	VA (50 Hz)/W	—/0.4	3.6/0.3	—/0.4	3.6/0.3
Operating range	V AC (50/60 Hz)	—	90...265	—	90...265
	V DC	4...32	—	4...32	—
Must drop-out voltage	V AC (50/60 Hz)/DC	3	24	3	24

Technical data

Electrical life	cycles	10 · 10 ⁶	10 · 10 ⁶
Operate/release time	ms	20/12	9/8
Insulation between input and output (1.2/50 µs)	kV	5	5
Ambient temperature	°C	-20...+70**	-20...+70**
Protection category		IP 20	IP 20

Approvals (according to type)



77.01.x.xxx.8050



**Zero-crossing switch-on
Suggested applications:**

- Lamp inrush current reduction (CFL - Compact Fluorescent energy-saving Lamps and similar)
- Heater control
- Solenoid, contactor driver

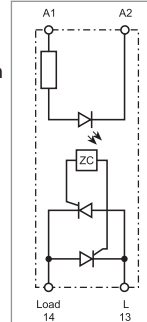

Simplified circuit diagram

77.01.x.xxx.8051



**Random switch-on
Suggested applications:**

- Finer control requiring short operate time (specially motor control)
- AC Input phase different from AC Output phase

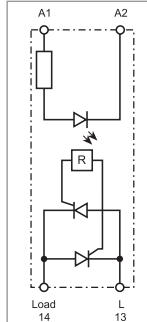

Simplified circuit diagram

7 - 15 A modular SSR, 1 NO DC output

- 17.5 mm housing
- 2 versions, for 24 and 125 V DC mosfet output
- 4 kV (1.2/50 μ s) insulation between Input and Output
- Short circuit protection
- High switching speed
- High endurance
- Silent switching
- Spark and bounce-free switching
- Low control power
- Suitable for railway applications
- 35 mm rail (EN 60715) mount

77.01
Box clamp



D

* See L77-3 and L77-4 diagrams page 17

For outline drawing see page 24

Output specification

Output configuration	1 NO (SPST-NO)	1 NO (SPST-NO)	
Rated current I_N /Max. peak current (10 ms)	A	15/160	7/60
Rated voltage	V DC	24	125
Switching voltage range	V DC	16...32	43...140
Rated load DC13	A	5	2.5
DC motor rating	kW	0.2	—
Minimum switching current	mA	100	50
Typical "OFF-state" leakage current	mA	3	6
Max "ON-state" voltage drop @ 25 °C and I_N	V	0.06	0.2
Power loss @ I_N	W	1	1.5

Input specification

Nominal voltage (U_N)	V DC	6...24	6...24
Rated power	W	0.4	0.4
Operating range	V DC	4...32	4...32
Must drop-out voltage	V DC	3	3

Technical data

Electrical life	cycles	$10 \cdot 10^6$	$10 \cdot 10^6$
Operate/release time	ms	0.05/2	0.05/2
Insulation between input and output (1.2/50 μ s)	kV	4	4
Ambient temperature	°C	-20...+70*	-20...+70*
Protection category		IP 20	IP 20

Approvals (according to type)



77.01.9.024.9024



**24 V DC output switching
15 A rated**

Applications in Energy, Automation and Machines:

- Control of electric, pneumatic and hydraulic electromagnetic valves
- Direct control of loads such as motors and electromagnets

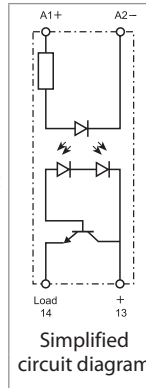

77.01.9.024.9125



**110...125 V DC output switching
7 A rated**

Applications in Energy, Automation and Machines:

- Control of electric, pneumatic and hydraulic electromagnetic valves
- Direct control of loads such as motors and electromagnets

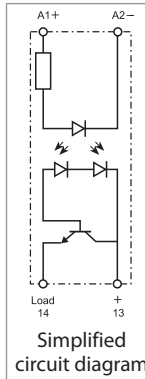

15 A modular SSR, 1 NO output

- 22.5 mm housing, heat-sink + plastic cover
- 24 to 277 V AC output (with TRIAC)
- 6 kV (1.2/50 µs) insulation between Input and Output
- Zero-crossing and random switch-on versions available
- High switching speed
- High endurance
- Silent switching
- Spark and bounce-free switching
- Low control power
- 3-phase general purpose
- "Relay-style" terminal arrangement (input and output terminals on opposite sides)
- 35 mm rail (EN 60715) mount

77.11
Box clamp



* See L77-9 diagram page 18
** See L77-5 diagrams page 17

For outline drawing see page 24

Output specification

Output configuration	1 NO (SPST-NO)		1 NO (SPST-NO)	
Rated current I_N /Max. peak current* (10 ms) A	15/400*		15/400*	
Rated voltage V AC (50/60 Hz)	230		230	
Switching voltage range V AC (50/60 Hz)	19...305		19...305	
Repetitive peak off-state voltage V_{pk}	800		800	
Rated load AC7a (cos φ = 0.8, @ 25 °C) A	20		20	
Rated load AC15 A	15		15	
Single phase motor rating (230 V AC) kW	—		0.75	
Nominal lamp rating:				
230 V incandescent/halogen W	4000		2500	
fluorescent tubes with electronic ballast W	4000		2500	
fluorescent tubes with electromagnetic ballast W	2000		1000	
CFL W	3000		1500	
230 V LED W	3000		1500	
LV halogen or LED with electronic ballast W	3000		1500	
LV halogen or LED with electromagnetic ballast W	3000		1500	
Minimum switching current @ 250 V mA	100		100	
Typical "OFF-state" leakage current @ 250 V mA	1		1	
Max "ON-state" voltage drop @ 25 °C and 15 A V	1.55		1.55	
Power loss @ 15 A W	14		14	

Input specification

Input specification	77.11.x.xxx.8250		77.11.x.xxx.8251	
Nominal voltage (U_N)	V AC (50/60 Hz)	—	230	—
	V DC	24	—	24
Rated power VA (50 Hz)/W	0.4	7.5/0.9	0.4	7.5/0.9
Operating range	V AC (50/60 Hz)	—	40...305	—
	V DC	4...32	—	4...32
Must drop-out voltage V AC (50/60 Hz)/DC	—/2	6/—	—/2	6/—

Technical data

Electrical life cycles	10 · 10 ⁶		10 · 10 ⁶	
Operate/release time ms	< 10/< 10	< 10/< 30	< 1/< 10	< 2/< 25
Insulation between input and output (1.2/50 µs) kV	6		6	
Ambient temperature °C	-20...+80**		-20...+80**	
Protection category	IP 20		IP 20	

Approvals (according to type)



77.11.x.xxx.8250



Zero-crossing switch-on
Suggested applications:

- Lamp inrush current reduction (CFL - Compact Fluorescent energy-saving Lamps and similar)
- Heater control
- Solenoid, contactor driver

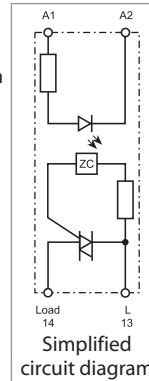

77.11.x.xxx.8251



Random switch-on
Suggested applications:

- Fine controls involving shorter time (specially motor control)

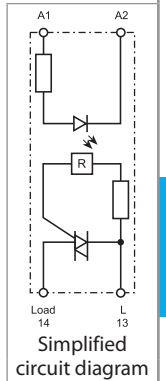

25 A modular SSR, 1 NO output

- 22.5 mm housing, heat-sink + plastic cover
- 24 to 277 V AC output (with TRIAC)
- 6 kV (1.2/50 μs) insulation between Input and Output
- Zero-crossing and random switch-on versions available
- High switching speed
- High endurance
- Silent switching
- Spark and bounce-free switching
- Low control power
- 3-phase general purpose
- "Relay-style" terminal arrangement (input and output terminals on opposite sides)
- 35 mm rail (EN 60715) mount

77.21
Box clamp



* See L77-10 diagram page 18
** See L77-6 diagrams page 17

For outline drawing see page 24

Output specification

Output configuration	1 NO (SPST-NO)		1 NO (SPST-NO)	
Rated current (@40 °C) I _N /Max. peak current* (10 ms)	A	25/400*		25/400*
Rated voltage	V AC (50/60 Hz)	230		230
Switching voltage range	V AC (50/60 Hz)	19...305		19...305
Repetitive peak off-state voltage	V _{pk}	800		800
Rated load AC7a (cos φ = 0.8, @ 25 °C)	A	25		25
Rated load AC15	A	25		25
Single phase motor rating (230 V AC)	kW	—		1
Nominal lamp rating:				
230 V incandescent/halogen W		4000		2500
fluorescent tubes with electronic ballast W		4000		2500
fluorescent tubes with electromagnetic ballast W		2000		1000
CFL W		3000		1500
230 V LED W		3000		1500
LV halogen or LED with electronic ballast W		3000		1500
LV halogen or LED with electromagnetic ballast W		3000		1500
Minimum switching current @ 250 V	mA	100		100
Typical "OFF-state" leakage current @ 250 V	mA	1		1
Max "ON-state" voltage drop @ 25 °C and 25 A	V	1.55		1.55
Power loss @ 25 A	W	14		14

Input specification

Nominal voltage (U _N)	V AC (50/60 Hz)	—	230	—	230
	V DC	24	—	24	—
Rated power @ U _{MAX}	VA (50 Hz)/W	0.4	7.5/0.9	0.4	7.5/0.9
Operating range	V AC (50/60 Hz)	—	40...305	—	40...305
	V DC	4...32	—	4...32	—
Must drop-out voltage	V AC (50/60 Hz)/DC	—/2	6/—	—/2	6/—

Technical data

Electrical life	cycles	10 · 10 ⁶		10 · 10 ⁶	
Operate/release time	ms	< 10/< 10	< 10/< 30	< 1/< 10	< 2/< 25
Insulation between input and output (1.2/50 μs)	kV	6		6	
Ambient temperature	°C	-20...+80**		-20...+80**	
Protection category		IP 20		IP 20	

Approvals (according to type)



NEW 77.21.x.xxx.8250



**Zero-crossing switch-on
Suggested applications:**

- Lamp inrush current reduction (CFL - Compact Fluorescent energy-saving Lamps and similar)
- Heater control
- Solenoid, contactor driver

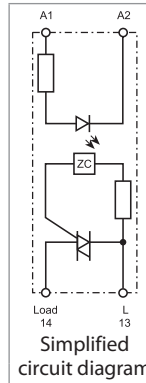

NEW 77.21.x.xxx.8251



**Random switch-on
Suggested applications:**

- Finer control requiring short operate time (specially motor control)

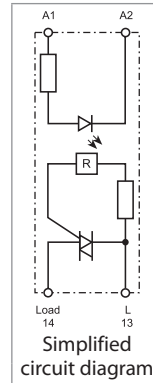

30 A modular SSR, 1 NO output

- 22.5 mm housing, heat-sink + plastic cover
- 60 to 440 V AC output (with back to back SCR)
- 6 kV (1.2/50 µs) insulation between Input and Output
- Zero-crossing and random switch-on versions available
- High switching speed
- High endurance
- Silent switching
- Spark and bounce-free switching
- Low control power
- 3-phase general purpose
- "Relay-style" terminal arrangement (input and output terminals on opposite sides)
- 35 mm rail (EN 60715) mount

77.31
Box clamp



* See L77-11 diagram page 18
** See L77-7 diagrams page 17

For outline drawing see page 24

Output specification

Output configuration	1 NO (SPST-NO)		1 NO (SPST-NO)	
Rated current I_N /Max. peak current* (10 ms) A	30/520*		30/520*	
Rated voltage V AC (50/60 Hz)	400		400	
Switching voltage range V AC (50/60 Hz)	48...480		48...480	
Repetitive peak off-state voltage V_{pk}	1100		1100	
Rated load AC7a (cos φ = 0.8) A	30		30	
Rated load AC15 A	20		20	
Single phase motor rating (230 V AC) kW	—		1.5	
Nominal lamp rating:				
230 V incandescent/halogen W	6000		4500	
fluorescent tubes with electronic ballast W	6000		4000	
fluorescent tubes with electromagnetic ballast W	3000		1800	
CFL W	4000		2500	
230 V LED W	4000		2500	
LV halogen or LED with electronic ballast W	4000		2500	
LV halogen or LED with electromagnetic ballast W	4000		2500	
Minimum switching current @ 400 V mA	300		300	
Typical "OFF-state" leakage current @ 400 V mA	1		1	
Max "ON-state" voltage drop @ 25 °C and 30 A V	0.85		0.85	
Power loss @ 30 A W	16		16	

Input specification

Nominal voltage (U_N)	V AC (50/60 Hz)	24	230	—	230
	V DC	24	—	24	—
Rated power @ U_{MAX}	VA (50 Hz)/W	0.24/0.4	7.5/0.9	0.4	7.5/0.9
Operating range	V AC (50/60 Hz)	—	40...280	—	40...280
	V DC	4...32	—	4...32	—
Must drop-out voltage	V AC (50/60 Hz)/DC	6/2	6/—	—/2	6/—

Technical data

Electrical life	cycles	10 · 10 ⁶		10 · 10 ⁶	
Operate/release time	ms	< 10/< 10	< 10/< 30	< 1/< 10	< 2/< 25
Insulation between input and output (1.2/50 µs)	kV	6		6	
Ambient temperature	°C	-20...+80**		-20...+80**	
Protection category		IP 20		IP 20	

Approvals (according to type)



77.31.x.xxx.8050



Zero-crossing switch-on Suggested applications:

- Lamp inrush current reduction (CFL - Compact Fluorescent energy-saving Lamps and similar)
- Heater control
- Solenoid, contactor driver

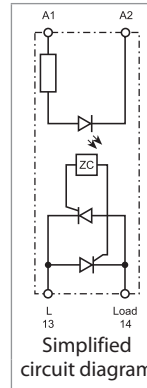

77.31.x.xxx.8051



Random switch-on Suggested applications:

- Finer control requiring short operate time (specially motor control)

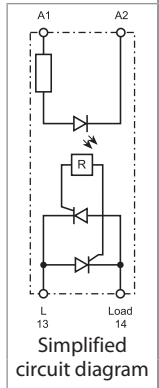

30 A modular SSR, 1 NO output

- 22.5 mm housing, heat-sink + plastic cover
- 60 to 440 V AC output (with back to back SCR)
- 6 kV (1.2/50 μs) insulation between Input and Output
- Zero-crossing and random switch-on versions available
- High switching speed
- High endurance
- Silent switching
- Spark and bounce-free switching
- Low control power
- 3-phase general purpose
- "Contactor-style" terminal arrangement (input and output terminals on adjacent sides)
- 35 mm rail (EN 60715) mount

77.31
Box clamp



* See L77-11 diagram page 18
** See L77-7 diagrams page 17

For outline drawing see page 24

Output specification

Output configuration	1 NO (SPST-NO)		1 NO (SPST-NO)	
Rated current I _N /Max. peak current* (10 ms) A	30/520*		30/520*	
Rated voltage V AC (50/60 Hz)	400		400	
Switching voltage range V AC (50/60 Hz)	48...480		48...480	
Repetitive peak off-state voltage V _{pk}	1100		1100	
Rated load AC7a (cos φ = 0.8) A	30		30	
Rated load AC15 A	20		20	
Single phase motor rating (230 V AC) kW	—		1.5	
Nominal lamp rating:				
230 V incandescent/halogen W	6000		4500	
fluorescent tubes with electronic ballast W	6000		4000	
fluorescent tubes with electromagnetic ballast W	3000		1800	
CFL W	4000		2500	
230 V LED W	4000		2500	
LV halogen or LED with electronic ballast W	4000		2500	
LV halogen or LED with electromagnetic ballast W	4000		2500	
Minimum switching current @ 400 V mA	300		300	
Typical "OFF-state" leakage current @ 400 V mA	1		1	
Max "ON-state" voltage drop @ 25 °C and 30 A V	0.85		0.85	
Power loss @ 30 A W	16		16	

Input specification

Nominal voltage (U _N)	V AC (50/60 Hz)	—	230	—	230
	V DC	24	—	24	—
Rated power VA (50 Hz)/W		0.4	7.5/0.9	0.4	7.5/0.9
Operating range	V AC (50/60 Hz)	—	40...280	—	40...280
	V DC	4...32	—	4...32	—
Must drop-out voltage V AC (50/60 Hz)/DC		—/2	6/—	—/2	6/—

Technical data

Electrical life cycles		10 · 10 ⁶		10 · 10 ⁶	
Operate/release time ms		< 10/< 10	< 10/< 30	< 1/< 10	< 2/< 25
Insulation between input and output (1.2/50 μs) kV		6		6	
Ambient temperature °C		-20...+80**		-20...+80**	
Protection category		IP 20		IP 20	

Approvals (according to type)



77.31.x.xxx.8070



Zero-crossing switch-on

Suggested applications:

- Lamp inrush current reduction (CFL - Compact Fluorescent energy-saving Lamps and similar)
- Heater control
- Solenoid, contactor driver

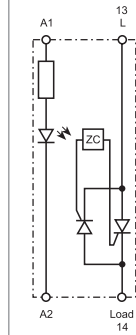

Simplified circuit diagram

77.31.x.xxx.8071



Random switch-on

Suggested applications:

- Fine controls involving shorter time (specially motor control)

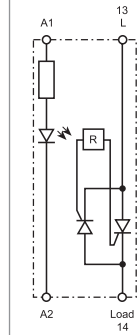

Simplified circuit diagram

25, 40 and 60 A panel Zero-crossing SSR, "hockey puck" style
Type 77.A1.x.xxx.8x50: 25 A
Type 77.B1.x.xxx.8x50: 40 A
Type 77.D1.x.xxx.8x50: 60 A
8250: 24 to 280 VAC switching load voltage
8650: 24 to 660 VAC switching load voltage

- "hockey puck" housing with folding screw cover
- High endurance and switching speed
- Silent switching
- Spark and bounce-free switching
- Low control power
- "Relay-style": input and output terminals on opposite sides
- Mounting on control cabinet sheet metal or on heatsink

77.A1/B1/D1
Screw terminal (plate clamp)



* See L77-13, L77-14 and L77-15 diagrams page 19

Four outline drawing see page 24

Output specification

Output configuration	1 NO	
Rated current I_N /Max. peak current (10 ms) A	25/300	
Rated voltage V AC (50/60 Hz)	240	600
Switching voltage range V AC (50/60 Hz)	24...280	24...660
Operating frequency range Hz	47...400	47...400
Repetitive peak off-state voltage V_{pk}	600	1600
Nominal lamp rating:		
230 V incandescent/halogen W	2000	4000
fluorescent tubes with electronic ballast W	2000	4000
fluorescent tubes with electromagnetic ballast W	1000	2000
CFL W	800	3000
230 V LED W	800	3000
LV halogen or LED with electronic ballast W	800	3000
LV halogen or LED with electromagnetic ballast W	1000	3000
Minimum switching current @ 250 V mA	100	100
Typical "OFF-state" leakage current @ rated voltage mA	0.1	0.1
Max "ON-state" voltage drop @ 25 °C and I_N V	1.5	1.5
Power loss @ I_N W	30	48

Input specification

Nominal voltage (U_N) V AC (50/60 Hz)	—	230
V DC	24	—
Rated power @ U_{MAX} VA (50 Hz)/W	—/0.55	5.3/—
Operating range V AC (50/60 Hz)	—	90...280
V DC	3...32	—
Must drop-out voltage V AC (50/60 Hz)/DC	—/1	15/—

Technical data

Electrical life cycles	—	
Operate/release time ms	10/10	40/20
Insulation between input and output (1.2/50 μ s) kV	—	
Ambient temperature °C	-30...+80*	
Protection category	IP 20	

Approvals (according to type)

NEW 77.A1.x.xxx.8x50



Zero-crossing switch-on

- Output: 25 A
- Suggested applications: heater control, lamps, solenoid, contactor driver

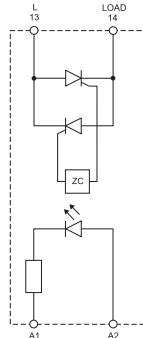

Simplified circuit diagram

NEW 77.B1.x.xxx.8x50



Zero-crossing switch-on

- Output: 40 A
- Suggested applications: heater control, lamps, solenoid, contactor driver

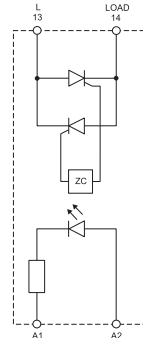

Simplified circuit diagram

NEW 77.D1.x.xxx.8x50



Zero-crossing switch-on

- Output: 60 A
- Suggested applications: heater control, lamps, solenoid, contactor driver

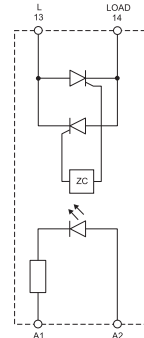

Simplified circuit diagram

	77...8250		77...8650		77...8250		77...8650	
Output configuration	1 NO		1 NO		1 NO		1 NO	
Rated current I_N /Max. peak current (10 ms) A	25/300		40/500		60/700		60/700	
Rated voltage V AC (50/60 Hz)	240	600	240	600	240	600	240	600
Switching voltage range V AC (50/60 Hz)	24...280	24...660	24...280	24...660	24...280	24...660	24...280	24...660
Operating frequency range Hz	47...400	47...400	47...400	47...400	47...400	47...400	47...400	47...400
Repetitive peak off-state voltage V_{pk}	600	1600	600	1600	600	1600	600	1600
Nominal lamp rating:								
230 V incandescent/halogen W	2000	4000	4000	7200	2000	4000	4000	7200
fluorescent tubes with electronic ballast W	2000	4000	4000	7200	1000	2000	2000	3600
fluorescent tubes with electromagnetic ballast W	1000	2000	2000	3600	800	3000	800	4800
CFL W	800	3000	3000	4800	800	3000	800	4800
230 V LED W	800	3000	3000	4800	800	3000	800	4800
LV halogen or LED with electronic ballast W	800	3000	3000	4800	1000	3000	1000	4800
LV halogen or LED with electromagnetic ballast W	1000	3000	3000	4800	100	100	100	100
Minimum switching current @ 250 V mA	100	100	100	100	0.1	0.1	0.1	0.1
Typical "OFF-state" leakage current @ rated voltage mA	0.1	0.1	0.1	0.1	1.5	1.5	1.5	1.5
Max "ON-state" voltage drop @ 25 °C and I_N V	1.5	1.5	1.5	1.5	30	48	30	48
Power loss @ I_N W	30	48	30	48	—	230	—	230
Nominal voltage (U_N) V AC (50/60 Hz)	—	230	—	230	—	230	—	230
V DC	24	—	24	—	24	—	24	—
Rated power @ U_{MAX} VA (50 Hz)/W	—/0.55	5.3/—	—/0.55	5.3/—	—/0.55	5.3/—	—/0.55	5.3/—
Operating range V AC (50/60 Hz)	—	90...280	—	90...280	—	90...280	—	90...280
V DC	3...32	—	3...32	—	3...32	—	3...32	—
Must drop-out voltage V AC (50/60 Hz)/DC	—/1	15/—	—/1	15/—	—/1	15/—	—/1	15/—
Electrical life cycles	—		—		—		—	
Operate/release time ms	10/10	40/20	10/10	40/20	10/10	40/20	10/10	40/20
Insulation between input and output (1.2/50 μ s) kV	—		—		—		—	
Ambient temperature °C	-30...+80*		-30...+80*		-30...+80*		-30...+80*	
Protection category	IP 20		IP 20		IP 20		IP 20	



80, 100 and 125 A panel Zero-crossing SSR, "hockey puck" style

Type 77.F1.x.xxx.8x50: 80 A

Type 77.G1.x.xxx.8x50: 100 A

Type 77.H1.x.xxx.8x50: 125 A

8250: 24 to 280 VAC switching load voltage

8650: 24 to 660 VAC switching load voltage

- "hockey puck" housing with folding screw cover
- High endurance and switching speed
- Silent switching
- Spark and bounce-free switching
- Low control power
- "Relay-style": input and output terminals on opposite sides
- Mounting on control cabinet sheet metal or on heatsink

77.F1/G1/H1
Screw terminal (plate clamp)



* See L77-16, L77-17 and L77-18 diagrams page 19

For outline drawing see page 24

NEW 77.F1.x.xxx.8x50



Zero-crossing switch-on

- Output: 80 A
- Suggested applications: heater control, lamps, solenoid, contactor driver

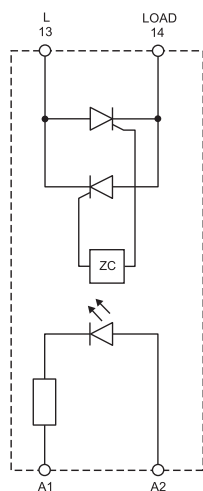

Simplified circuit diagram

NEW 77.G1.x.xxx.8x50



Zero-crossing switch-on

- Output: 100 A
- Suggested applications: heater control, lamps, solenoid, contactor driver

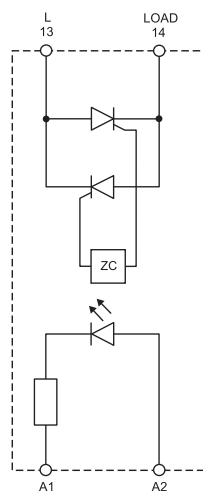

Simplified circuit diagram

NEW 77.H1.x.xxx.8x50



Zero-crossing switch-on

- Output: 125 A
- Suggested applications: heater control, lamps, solenoid, contactor driver

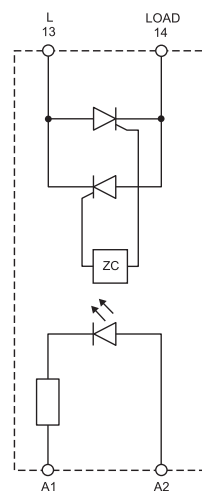

Simplified circuit diagram

Output specification		77...8250		77...8650	
		77...8250	77...8650	77...8250	77...8650
Output configuration		1 NO			
Rated current I_N /Max. peak current (10 ms)	A	80/800			
Rated voltage	V AC (50/60 Hz)	240	600	240	600
Switching voltage range	V AC (50/60 Hz)	24...280	24...660	24...280	24...660
Operating frequency range	Hz	47...400	47...400	47...400	47...400
Repetitive peak off-state voltage	V_{pk}	600	1600	600	1600
Minimum switching current @ 250 V	mA	100			
Typical "OFF-state" leakage current @ rated voltage	mA	0.1			
Max "ON-state" voltage drop @ 25 °C and I_N	V	1.5			
Power loss @ I_N	W	96			
Input specification		77...8250		77...8650	
Nominal voltage (U_N)	V AC (50/60 Hz)	—		230	
	V DC	24		—	
Rated power @ U_{MAX}	VA (50 Hz)/W	—/0.55		5.3/—	
Operating range	V AC (50/60 Hz)	—		90...280	
	V DC	3...32		—	
Must drop-out voltage	V AC (50/60 Hz)/DC	—/1		15/—	
Technical data		77...8250		77...8650	
Electrical life	cycles	—			
Operate/release time	ms	10/10	40/20	10/10	40/20
Insulation between input and output (1.2/50 μ s)	kV	—			
Ambient temperature	°C	-30...+80*			
Protection category		—			
Approvals (according to type)					

25, 50 and 75 A dual phase Random SSR, "hockey puck" style with 2 independent channel

Type 77.A2.9.024.8671: 25 A - 600 V AC

Type 77.C2.9.024.8671: 50 A - 600 V AC

Type 77.E2.9.024.8671: 75 A - 600 V AC

- 2 independent output channel driven by independent low power DC input
- "hockey puck" housing with folding screw cover
- High endurance and switching speed
- Silent switching
- Spark and bounce-free switching
- "contactor-style": input and output terminals on adjacent sides
- Mounting on control cabinet sheet metal or on heatsink

77.A2/C2/E2

Screw terminal (plate clamp)



NEW 77.A2.9.024.8671



Random switch-on

- Output: 25 A/600 V AC
- Suggested applications: heater or motor control

NEW 77.C2.9.024.8671



Random switch-on

- Output: 50 A/600 V AC
- Suggested applications: heater or motor control

NEW 77.E2.9.024.8671



Random switch-on

- Output: 75 A/600 V AC
- Suggested applications: heater or motor control

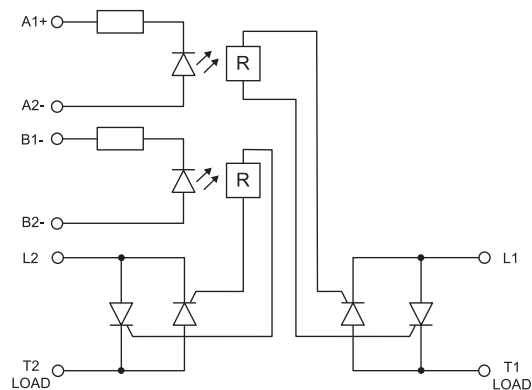

Simplified circuit diagram

* See L77-19, L77-20 and L77-21 diagrams page 20

For outline drawing see page 24

Output specification			
Output configuration		2 NO	2 NO
Rated current I_N /Max. peak current (10 ms)	A	25/300	50/500
Rated voltage	V AC (50/60 Hz)	600	600
Switching voltage range	V AC (50/60 Hz)	24...660	24...660
Operating frequency range	Hz	47...400	47...400
Repetitive peak off-state voltage	V_{pk}	1200	1200
Minimum switching current @ 600 V	mA	—	—
Typical "OFF-state" leakage current @ rated voltage	mA	5	5
Max "ON-state" voltage drop @ 25 °C and I_N	V	1.5	1.5
Power loss @ I_N	W	60	120
Input specification			
Nominal voltage (U_N)	V DC	24	24
Rated power @ U_{MAX}	W	0.3	0.3
Operating range	V DC	4...32	4...32
Must drop-out voltage	V AC (50/60 Hz)/DC	1	1
Technical data			
Electrical life	cycles	—	—
Operate/release time	ms	1/10	1/10
Insulation between input and output (1.2/50 μ s)	kV	—	—
Ambient temperature	°C	-30...+80*	-30...+80*
Protection category		—	—
Approvals (according to type)			

25 and 40 A three phase Random SSR, "hockey puck" style

Type 77.A3.x.xxx.8671: 25 A - 600 V AC

Type 77.B3.x.xxx.8671: 40 A - 600 V AC

- High endurance and switching speed
- Silent switching
- Spark and bounce-free switching
- Low control power
- "contactor-style": input and output terminals on adjacent sides
- Mounting on control cabinet sheet metal or on heatsink

NEW 77.A3.x.xxx.8671



NEW 77.B3.x.xxx.8671



Random switch-on

- Output: 25 A/600 V AC
- Suggested applications: heater or motor control

Random switch-on

- Output: 40 A/600 V AC
- Suggested applications: heater or motor control

77.A3/B3
Screw terminal (plate clamp)

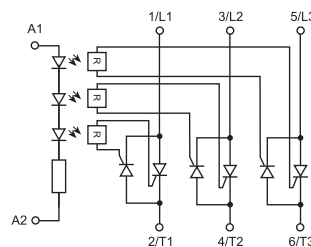

Simplified circuit diagram

* See L77-22 and L77-23 diagrams page 20

For outline drawing see page 24

Output specification		77.A3.x.xxx.8671		77.B3.x.xxx.8671	
Output configuration		3 NO		3 NO	
Rated current I _N /Max. peak current (10 ms)	A	25/300		40/500	
Rated voltage	V AC (50/60 Hz)	600		600	
Switching voltage range	V AC (50/60 Hz)	24...660		24...660	
Operating frequency range	Hz	47...400		47...400	
Repetitive peak off-state voltage	V _{pk}	1600		1600	
Minimum switching current @ 600 V	mA	—		—	
Typical "OFF-state" leakage current @ rated voltage	mA	10		10	
Max "ON-state" voltage drop @ 25 °C and I _N	V	1.6		1.6	
Power loss @ I _N	W	90		144	
Input specification		77.A3.x.xxx.8671		77.B3.x.xxx.8671	
Nominal voltage (U _N)	V AC (50/60 Hz)	—	230	—	230
	V DC	24	—	24	—
Rated power @ U _{MAX}	VA (50 Hz)/W	—/0.55	5.3/—	—/0.55	5.3/—
Operating range	V AC (50/60 Hz)	—	90...280	—	90...280
	V DC	4...32	—	4...32	—
Must drop-out voltage	V AC (50/60 Hz)/DC	1	15	1	15
Technical data		77.A3.x.xxx.8671		77.B3.x.xxx.8671	
Electrical life	cycles	—		—	
Operate/release time	ms	1	10/20	1	10/20
Insulation between input and output (1.2/50 μs)	kV	—		—	
Ambient temperature	°C	-30...+80*		-30...+80*	
Protection category		—		—	
Approvals (according to type)					

60 and 80 A three phase Random SSR, "hockey puck" style

Type 77.D3.x.xxx.8671: 60 A - 600 V AC

Type 77.F3.x.xxx.8671: 80 A - 600 V AC

- High endurance and switching speed
- Silent switching
- Spark and bounce-free switching
- Low control power
- "contactor-style": input and output terminals on adjacent sides
- Mounting on control cabinet sheet metal or on heatsink

NEW 77.D3.x.xxx.8671



Random switch-on

- Output: 60 A/600 V AC
- Suggested applications: heater or motor control

NEW 77.F3.x.xxx.8671



Random switch-on

- Output: 80 A/600 V AC
- Suggested applications: heater control

77.D3/F3

Screw terminal (plate clamp)

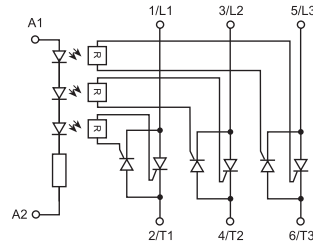

Simplified circuit diagram

* See L77-24 and L77-25 diagrams page 20

For outline drawing see page 24

Output specification					
Output configuration		3 NO		3 NO	
Rated current I_N /Max. peak current (10 ms)	A	60/700		80/1280	
Rated voltage	V AC (50/60 Hz)	600		600	
Switching voltage range	V AC (50/60 Hz)	24...660		24...660	
Operating frequency range	Hz	47...400		47...400	
Repetitive peak off-state voltage	V_{pk}	1600		1600	
Minimum switching current @ 600 V	mA	—		—	
Typical "OFF-state" leakage current @ 600 V	mA	10		10	
Max "ON-state" voltage drop @ 25 °C and I_N	V	1.6		1.6	
Power loss @ I_N	W	216		288	
Input specification					
Nominal voltage (U_N)	V AC (50/60 Hz)	—	230	—	230
	V DC	24	—	24	—
Rated power @ U_{MAX}	VA (50 Hz)/W	—/0.55	5.3/—	—/0.55	5.3/—
Operating range	V AC (50/60 Hz)	—	90...280	—	90...280
	V DC	4...32	—	4...32	—
Must drop-out voltage	V AC (50/60 Hz)/DC	1	15	1	15
Technical data					
Electrical life	cycles	—		—	
Operate/release time	ms	1	10/20	1	10/20
Insulation between input and output (1.2/50 μ s)	kV	—		—	
Ambient temperature	°C	-30...+80*		-30...+80*	
Protection category		—		—	
Approvals (according to type)					

Ordering information DIN rail SSR

Example: 77 series modular SSR, 1 output 30 A AC, input voltage 230 V AC, relay style terminals arrangement, zero-crossing switch-on.

7 7 . 3 1 . 8 . 2 3 0 . A 8 B 0 C 5 D 0

Series

Type/rated current
0 = 5/7/15 A output (77.01)
1 = 15 A output (77.11)
2 = 25 A output (77.21)
3 = 30 A output (77.31)

No. of poles/mounting
1 = 1 pole, modular housing
(plastic or heat sink/plastic), DIN rail mounting

Input version
8 = AC (50/60 Hz)
9 = DC

Supply voltage
See "input specification"

Codes/Module width

77.01.8.230.8050/17.5 mm 5 A	77.11.8.230.8250/22.5 mm 15 A	77.21.8.230.8250/22.5 mm 25 A	77.31.8.024.8050/22.5 mm 30 A
77.01.9.024.8050/17.5 mm 5 A	77.11.9.024.8250/22.5 mm 15 A	77.21.9.024.8250/22.5 mm 25 A	77.31.8.230.8050/22.5 mm 30 A
77.01.8.230.8051/17.5 mm 5 A	77.11.8.230.8251/22.5 mm 15 A	77.21.8.230.8251/22.5 mm 25 A	77.31.9.024.8050/22.5 mm 30 A
77.01.9.024.8051/17.5 mm 5 A	77.11.9.024.8251/22.5 mm 15 A	77.21.9.024.8251/22.5 mm 25 A	77.31.8.230.8051/22.5 mm 30 A
77.01.9.024.9125/17.5 mm 7 A			77.31.9.024.8051/22.5 mm 30 A
77.01.9.024.9024/17.5 mm 15 A			77.31.8.230.8070/22.5 mm 30 A
			77.31.9.024.8070/22.5 mm 30 A
			77.31.8.230.8071/22.5 mm 30 A
			77.31.9.024.8071/22.5 mm 30 A

D: Switch-on mode
0 = Zero-crossing
1 = Random

C: Terminals arrangement
5 = "Relay style" (input and output on opposite sides)
7 = "Contactor style" (input and output on adjacent sides)

AB: Output circuit
(rated voltage)
80 = 230 V AC (77.01), 400 V AC (77.31)
82 = 230 V AC (77.11, 77.21)
9024 = 24 V DC
9125 = 110...125 V DC

Ordering information hockey puck SSR

Example: 77 series modular SSR, 1 output 25 A AC, input voltage 230 V AC, relay style terminals arrangement, zero-crossing switch-on.

7 7 . A 1 . 8 . 2 3 0 . A 8 B 2 C 5 D 0

Series

Type/rated current
A = 25 A output
B = 40 A output
C = 50 A output
D = 60 A output
E = 75 A output
F = 80 A output
G = 100 A output
H = 125 A output

No. of poles/mounting
1 = 1 phase, heat-sink or directly panel mounting
("hockey puck")
2 = 2 phases
3 = 3 phases

Input version
8 = AC (50/60 Hz)
9 = DC

Supply voltage
See "input specification"

Codes/Module width

1 phase 25 - 40 - 60 - 80 - 100 - 125 A	2 phases 25 - 50 - 75 A	3 phases 25 - 40 - 60 - 80 A
77.x1.8.230.8250/"hockey puck"	77.x2.9.024.8671/"hockey puck"	77.x3.8.230.8671/"hockey puck"
77.x1.9.024.8250/"hockey puck"		77.x3.9.024.8671/"hockey puck"
77.x1.8.230.8650/"hockey puck"		
77.x1.9.024.8650/"hockey puck"		

D: Switch-on mode
0 = Zero-crossing
1 = Random

C: Terminals arrangement
5 = "Relay style" (input and output on opposite sides)
7 = "Contactor style" (input and output on adjacent sides)

AB: Output circuit
(rated voltage)
82 = 230 V AC
86 = 600 V AC

Technical data

Insulation			77.01.8xxx		77.01.9xxx		77.11		77.21		77.31		
			Dielectric strength	Impulse (1.2/50 µs)	Dielectric strength	Impulse (1.2/50 µs)	Dielectric strength	Impulse (1.2/50 µs)	Dielectric strength	Impulse (1.2/50 µs)	Dielectric strength	Impulse (1.2/50 µs)	
Between input and output			2500 V AC	5 kV	3000 V AC	4 kV	3000 V AC	6 kV	3000 V AC	6 kV	3000 V AC	6 kV	
Between input and ground (heat-sink)			—	—	—	—	3000 V AC	6 kV	3000 V AC	6 kV	3000 V AC	6 kV	
Between output and ground (heat-sink)			—	—	—	—	2500 V AC	4 kV	2500 V AC	4 kV	4000 V AC	6 kV	
EMC specifications		Reference standard	77.01.8.230		77.01.9.024		77.11		77.21		77.31		
			230 V AC		24 V DC		24 V DC	230 V AC	24 V DC	230 V AC	24 V AC/DC	230 V AC	
Electrostatic discharge	contact discharge	EN 61000-4-2	4 kV		4 kV		4 kV		4 kV		4 kV		
	air discharge	EN 61000-4-2	8 kV		8 kV		8 kV		8 kV		8 kV		
Radiated electromagnetic field (80...1000 MHz)			EN 61000-4-3		30 V/m		20 V/m		20 V/m		30 V/m		
Fast transients on supply terminals (burst 5/50 ns, 5 and 100 kHz)			EN 61000-4-4		1 kV		1 kV		1 kV	3 kV	1 kV	3 kV	
Voltage pulses on supply terminals (surge 1.2/50 µs)	common mode	EN 61000-4-5	—		—		3 kV	3 kV	3 kV	3 kV	3 kV	3 kV	
	differential mode	EN 61000-4-5	1 kV		0.5 kV		0.5 kV	1.5 kV	0.5 kV	1.5 kV	0.5 kV	1.5 kV	
Radio-frequency common mode voltage (0.15...230 MHz) on supply terminals			EN 61000-4-6		10 V		10 V		10 V		10 V		
Terminals			77.01.x.xxx		77.01.9.xxx		77.11		77.21		77.31		
Screw torque			Nm		0.8		0.8		0.8		0.8		
Max. wire size			solid cable	stranded cable	solid cable	stranded cable	solid cable	stranded cable	solid cable	stranded cable	solid cable	stranded cable	
			mm ²	1 x 6 / 2 x 4	1 x 4 / 2 x 25	1 x 6 / 2 x 4	1 x 4 / 2 x 25	1 x 6 / 2 x 4	1 x 6 / 2 x 4	1 x 6 / 2 x 4	1 x 6 / 2 x 4	1 x 6 / 2 x 4	1 x 6 / 2 x 4
			AWG	1 x 10 / 2 x 12	1 x 12 / 2 x 14	1 x 10 / 2 x 12	1 x 12 / 2 x 14	1 x 10 / 2 x 12	1 x 10 / 2 x 12	1 x 10 / 2 x 12	1 x 10 / 2 x 12		
Wire strip length			mm		9		9		9		9		
Other data													
Power lost to the environment			without output current	W		0.5		0.5		0.9		0.9	
			with rated current	W		4.0		4.0		14		15	

			77.X1		77.X2		77.X3	
			Dielectric strength		Dielectric strength		Dielectric strength	
Between Input and output			4 kV		4 kV		4 kV	
Between input and ground (heat-sink)			4 kV		2.5 kV		2.5 kV	
Terminals								
Screw torque	Input side	Nm	1.5		0.5		0.5	
	Output side	Nm	2.2		2.2		2.2	
	On heatsink with thermal pad or paste	Nm	2.2		2.2		2.2	

77.X1 wiring cross section area		
Load current (A)	Cross section area of wire (mm ²)	Wire size (AWG)
15-20	2.5	12
20-35	4	10
25-32	6	10
32-50	10	8
50-65	16	6
65-85	25	4

Note: if the wire cross section area is bigger than 25 mm², we suggest to use 2 smaller cross section wires and connect them back to back superimposed (in parallel).

Input specification

77.01

Nominal voltage	Input code	Operating range				Must drop-out voltage (AC/DC)	Input current I_N at U_N
		AC		DC			
		U_{min}	U_{max}	U_{min}	U_{max}		
U_N		V	V	V	V	V	mA
24	9.024	—	—	4	32	3.0	18
230	8.230	90	265	—	—	24	15

77.11/77.21

Nominal voltage	Input code	Operating range				Must drop-out voltage (AC/DC)	Input current I_N at U_N
		AC		DC			
		U_{min}	U_{max}	U_{min}	U_{max}		
U_N		V	V	V	V	V	mA
24	9.024	—	—	4	32	2	11
230	8.230	40	305	—	—	6	25

77.31

Nominal voltage	Input code	Operating range				Must drop-out voltage (AC/DC)	Input current I_N at U_N
		AC		DC			
		U_{min}	U_{max}	U_{min}	U_{max}		
U_N		V	V	V	V	V	mA
24	8.024	16	32	—	—	6	10
24	9.024	—	—	4	32	2	11
230	8.230	40	280	—	—	6	25

77.x1.x.xxx.8x50

Nominal voltage	Input code	Operating range				Must drop-out voltage (AC/DC)	Input current I_N at U_N
		AC		DC			
		U_{min}	U_{max}	U_{min}	U_{max}		
U_N		V	V	V	V	V	mA
24	9.024	—	—	3	32	1.25	25
230	8.230	90	280	—	—	1.25	35



77.x2.9.024.8671



Nominal voltage	Input code	Operating range				Must drop-out voltage (AC/DC)	Input current I_N at U_N
		AC		DC			
		U_{min}	U_{max}	U_{min}	U_{max}		
U_N		V	V	V	V	V	mA
24	9.024	—	—	4	32	1.5	25

77.x3.x.xxx.8671

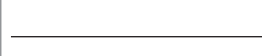
Nominal voltage	Input code	Operating range				Must drop-out voltage (AC/DC)	Input current I_N at U_N
		AC		DC			
		U_{min}	U_{max}	U_{min}	U_{max}		
U_N		V	V	V	V	V	mA
24	9.024	—	—	4	32	1.6	35
230	8.230	90	280	—	—	1.6	30

Led indication

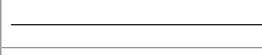
LED	Supply voltage
	OFF
	ON

LED (77.01.9.024.9xxx only)	Short circuit*
	NO
	YES

*To restore normal operation it is necessary to disconnect the power, resolve the short circuit and then restore power.

Output specification

L77-1 Output RMS current v ambient temperature
77.01.9.024.805x @ 32 V DC

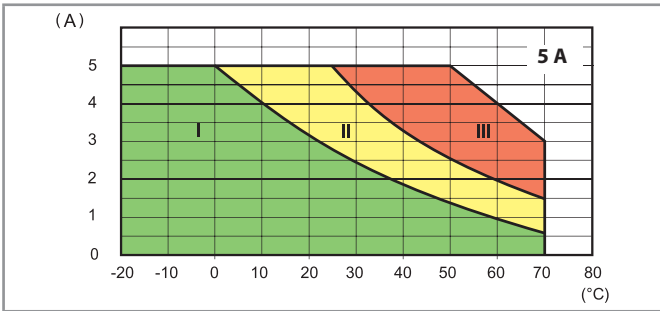

- I - Modular SSR installed as a group (without gap)
- II - Modular SSR installed as a group (9 mm gap between each SSR)
- III - Modular SSR installed individually in free air (without a significant influence from nearby components)

L77-2 Output RMS current v ambient temperature
77.01.8.230.805x @ 265 V AC

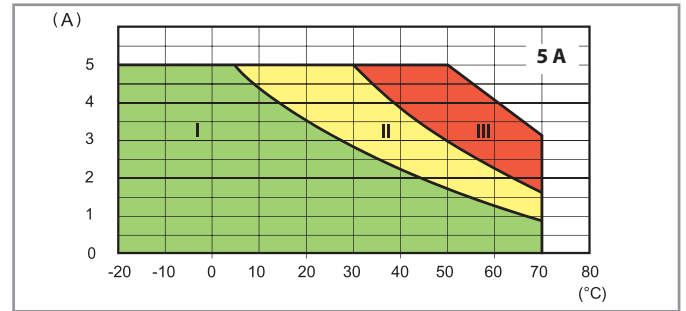

L77-3 Output DC current v ambient temperature
77.01.9.024.9024 @ 32 V DC

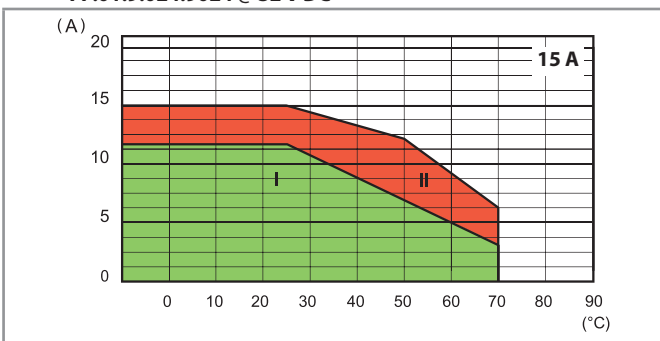

- I - Modular SSR installed as a group (without gap)
- II - Modular SSR installed individually in free air, or with a gap ≥ 9 mm, which implies a not significant influence from nearby components

L77-4 Output DC current v ambient temperature
77.01.9.024.9125 @ 32 V DC

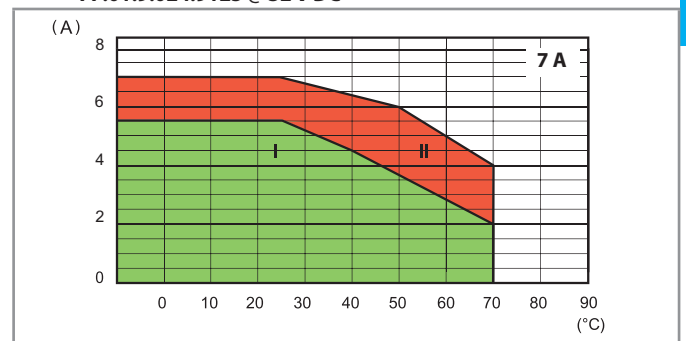

L77-5 Output RMS current v ambient temperature
77.11.x.xxx.82xx

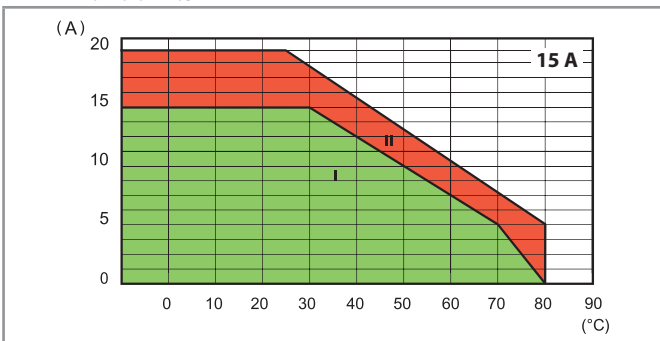

- I - Modular SSR installed as a group (without gap)
- II - Modular SSR installed individually in free air, or with a gap ≥ 20 mm, which implies a not significant influence from nearby components

L77-6 Output RMS current v ambient temperature
77.21.x.xxx.825x

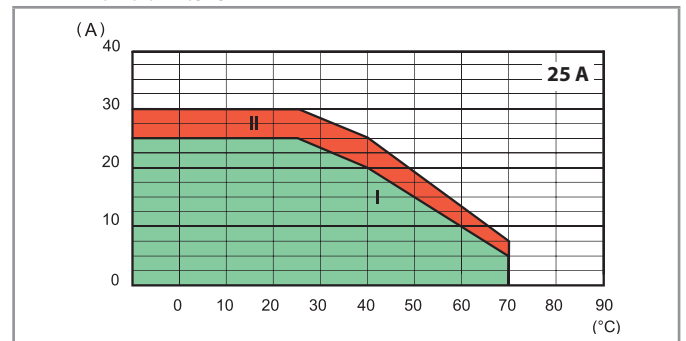

- I - Modular SSR installed as a group (without gap)
- II - Modular SSR installed individually in free air, or with a gap ≥ 20 mm, which implies a not significant influence from nearby components

L77-7 Output RMS current v ambient temperature
77.31.x.xxx.80xx

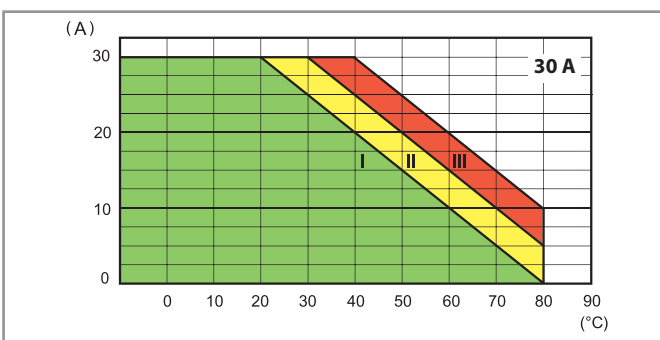

- I - Modular SSR installed as a group (without gap)
- II - Modular SSR installed as a group (20 mm gap between each SSR)
- III - Modular SSR installed individually in free air, or with a gap ≥ 40 mm, which implies a not significant influence from nearby components)

Output specification

L77-8 Inrush peak current (AC) v inrush time
77.01.x.xxx.80xx

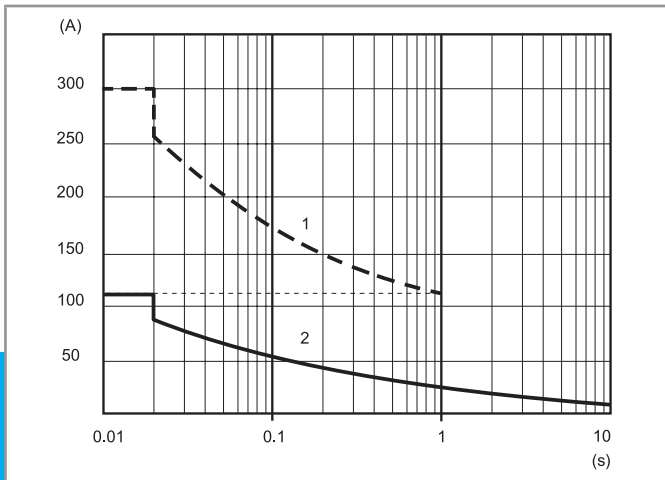

L77-9 Inrush peak current (AC) v inrush time
77.11.x.xxx.82xx

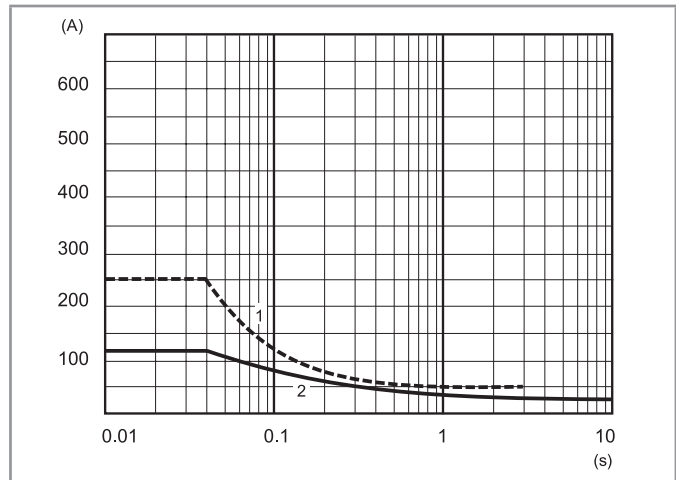

L77-10 Inrush peak current (AC) v inrush time
77.21.x.xxx.825x

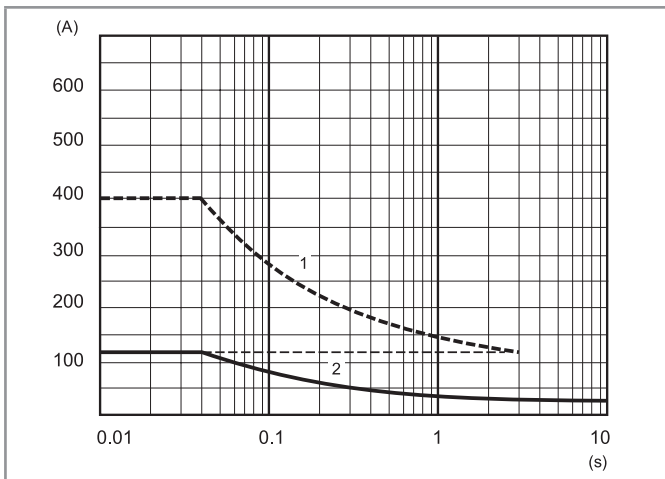

L77-11 Inrush peak current (AC) v inrush time
77.31.x.xxx.80xx

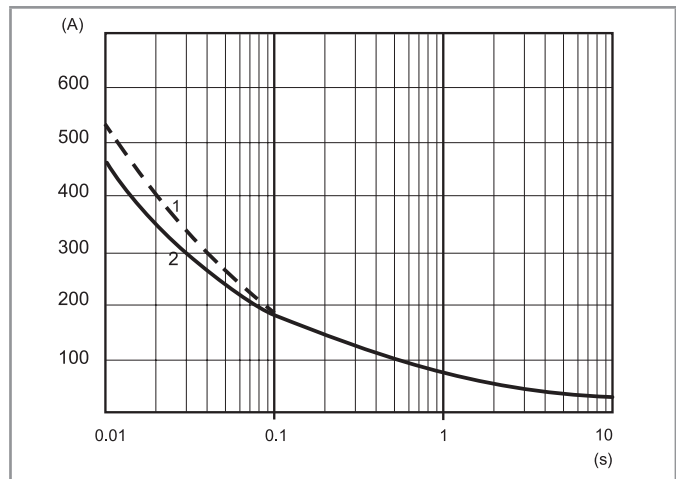

1 - "Cold" conditions (ambient temperature = 23 °C, no output current during the last 15 minutes)
2 - "Hot" conditions (ambient temperature = 50 °C, rated output current)

Output specification

L77-13 Output RMS current v ambient temperature
77.A1.x.xxx.8x50

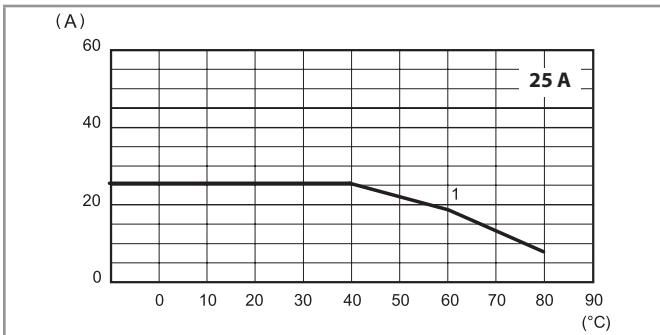

1 - Installation on heat-sink (2 K/W)

L77-14 Output RMS current v ambient temperature
77.B1.x.xxx.8x50

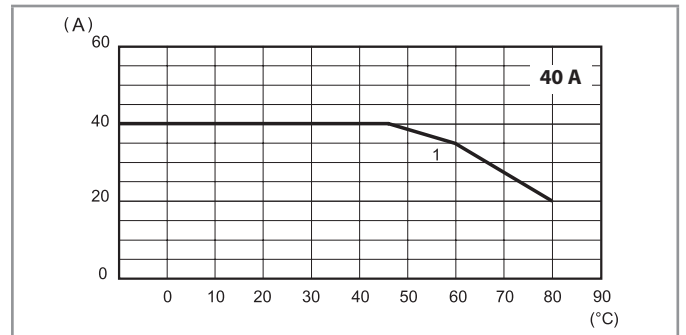

1 - Installation on heat-sink (0.9 K/W)

L77-15 Output RMS current v ambient temperature
77.D1.x.xxx.8x50

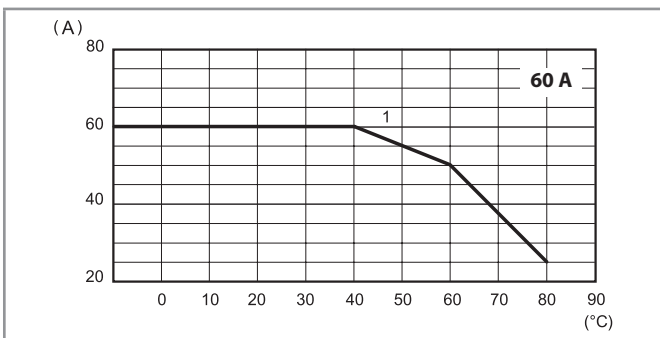

1 - Installation on heat-sink (0.7 K/W)

L77-16 Output RMS current v ambient temperature
77.F1.x.xxx.8x50

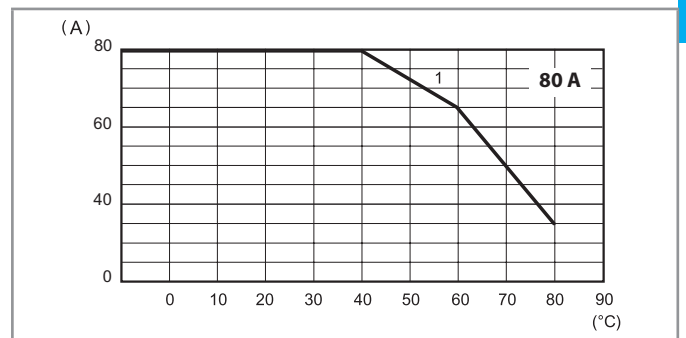

1 - Installation on heat-sink (0.5 K/W)

L77-17 Output RMS current v ambient temperature
77.G1.x.xxx.8x50

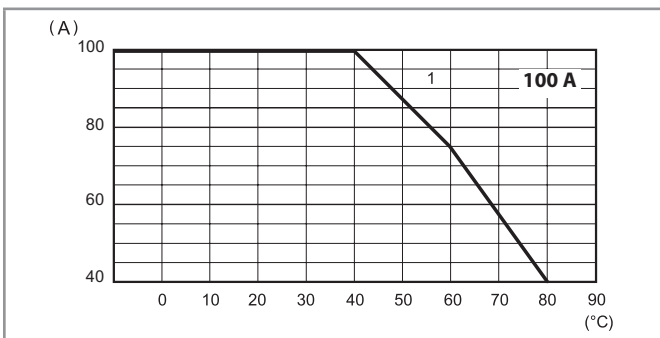

1 - Installation on heat-sink (0.45 K/W)

L77-18 Output RMS current v ambient temperature
77.H1.x.xxx.8x50

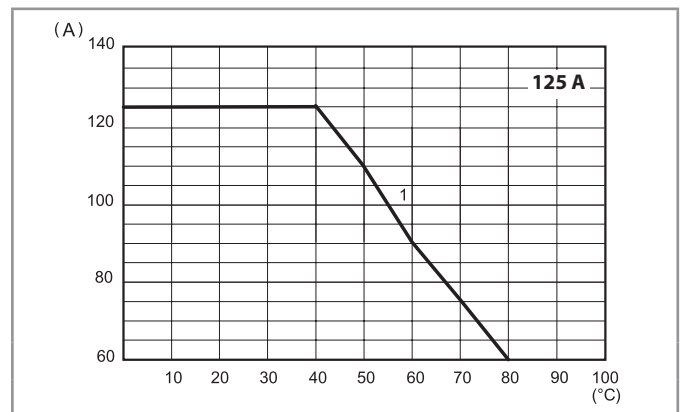

1 - Installation on heat-sink (0.35 K/W)

Output specification

L77-19 Output RMS current v ambient temperature
77.A2.9.024.8671

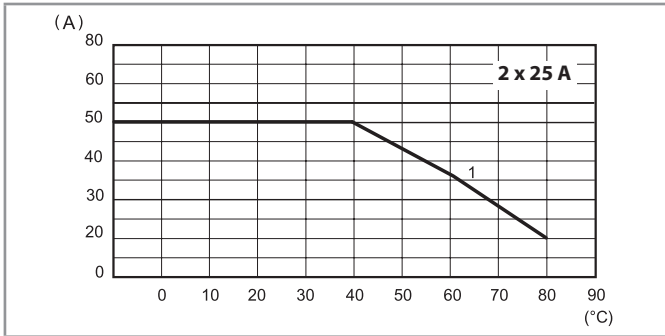

1 - Installation on heat-sink (0.9 K/W)

L77-20 Output RMS current v ambient temperature
77.C2.9.024.8671

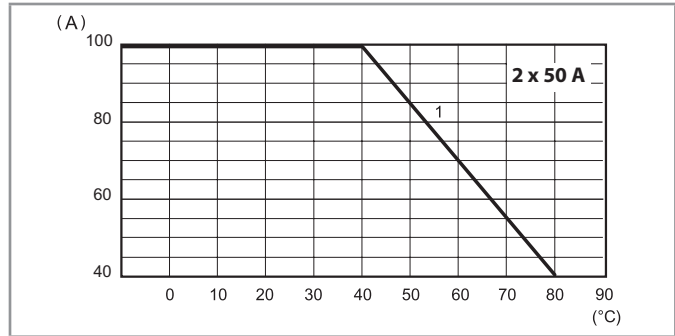

1 - Installation on heat-sink (0.45 K/W)

L77-21 Output RMS current v ambient temperature
77.E2.9.024.8671

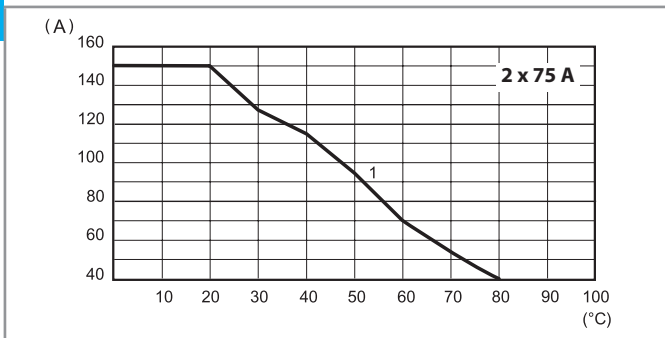

1 - Installation on heat-sink (0.45 K/W)

L77-22 Output RMS current v ambient temperature
77.A3.x.xxx.8671

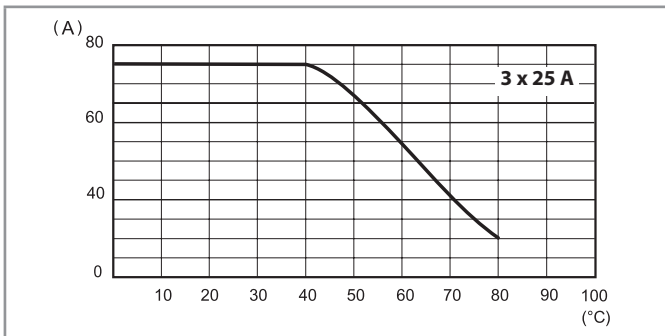

1 - Installation on heat-sink (0.7 K/W)

L77-23 Output RMS current v ambient temperature
77.B3.x.xxx.8671

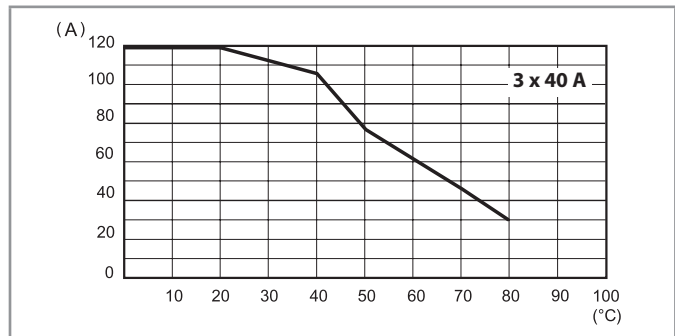

1 - Installation on heat-sink (0.5 K/W)

L77-24 Output RMS current v ambient temperature
77.D3.x.xxx.8671

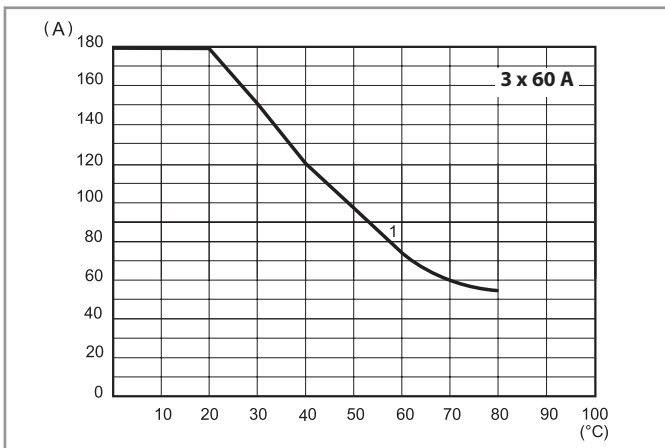

1 - Installation on heat-sink (0.45 K/W)

L77-25 Output RMS current v ambient temperature
77.F3.x.xxx.8671

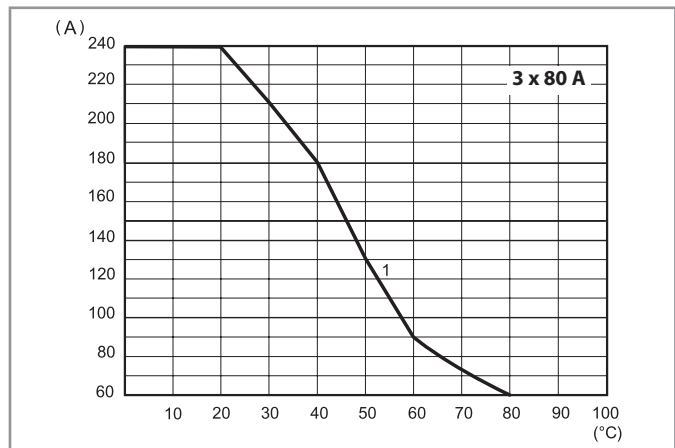

1 - Installation on heat-sink (0.35 K/W)

D

Output specification

Max recommended switching frequency (Cycles/Hour, with 50% Duty-cycle)				
Load	77.01.9xxx	77.01.9xxx	77.11/21	77.31
5 A 230 V (AC1)	5000	—	—	—
5 A 24 V DC L/R = 20 ms	—	3600	—	—
1 A (AC15)	10000	—	—	—
0.5 A (AC15)	20000	—	—	—
15 A 305 V cos φ = 0.8	—	—	1800	—
15 A 305 V cos φ = 0.5	—	—	1200	—
30 A 480 V cos φ = 0.8	—	—	—	1800
30 A 480 V cos φ = 0.5	—	—	—	1200
25 A 230 V cos φ = 0.7	—	—	—	—
40 A 230 V cos φ = 0.7	—	—	—	—
50 A 230 V cos φ = 0.7	—	—	—	—

Other data				
	77.01.8xxx	77.01.9xxx	77.11/21	77.31
Critical rising voltage dv/dt without input control (gate open) @ T _j = 125 °C	> 1000 V/μs	> 1000 V/μs	> 500 V/μs > 10 V/μs (with di/dt = 20 A/ms)	> 1000 V/μs
Critical rising current di/dt @ T _j = 125 °C	> 50 A/μs	> 50 A/μs	> 50 A/μs	> 150 A/μs
I²t for fusing @ t _p = 10 ms	450 A ² s	450 A ² s	1000 A ² s*	1350 A ² s**

Suggested fuse (depending on application) for short-circuit protection (Ultra-Fast acting types for semiconductors):

* 20 A, 660 V AC, 10 x 38 mm, 200 kA, 360 A²s.

** 30 A, 660 V AC, 10 x 38 mm, 200 kA, 1000 A²s.

Max recommended switching frequency (Cycles/Hour, with 50% Duty-cycle)						
Load	77.A1.x.xxx	77.B1.x.xxx	77.D1.x.xxx	77.F1.x.xxx	77.G1.x.xxx	77.H1.x.xxx
25 A 230 V cos φ = 0.7	1800	—	—	—	—	—
40 A 230 V cos φ = 0.7	—	1800	—	—	—	—
60 A 230 V cos φ = 0.7	—	—	1800	—	—	—
80 A 230 V cos φ = 0.7	—	—	—	1800	—	—
100 A 230 V cos φ = 0.7	—	—	—	—	1800	—
125 A 230 V cos φ = 0.7	—	—	—	—	—	1800

Other data						
	77.A1.x.xxx	77.B1.x.xxx	77.D1.x.xxx	77.F1.x.xxx	77.G1.x.xxx	77.H1.x.xxx
Critical rising voltage dv/dt without input control (gate open) @ T _j = 125 °C	500 V/μs	500 V/μs	500 V/μs	500 V/μs	500 V/μs	500 V/μs
I²t for fusing @ t _p = 10 ms	450 A ² s	1250 A ² s	2450 A ² s*	3200 A ² s**	11 250 A ² s	25 000 A ² s

Max recommended switching frequency (Cycles/Hour, with 50% Duty-cycle)			
Load	77.A2.x.xxx	77.C2.x.xxx	77.E2.x.xxx
25 A 230 V cos φ = 0.7	1800	—	—
50 A 230 V cos φ = 0.7	—	1800	—
75 A 230 V cos φ = 0.7	—	—	1800

Other data			
	77.A2.x.xxx	77.C2.x.xxx	77.E2.x.xxx
Critical rising voltage dv/dt without input control (gate open) @ T _j = 125 °C	500 V/μs	500 V/μs	500 V/μs
I²t for fusing @ t _p = 10 ms	450 A ² s	2110 A ² s	2810 A ² s*

Max recommended switching frequency (Cycles/Hour, with 50% Duty-cycle)				
Load	77.A3.x.xxx	77.B3.x.xxx	77.D3.x.xxx	77.F3.x.xxx
25 A 230 V cos φ = 0.7	1800	—	—	—
40 A 230 V cos φ = 0.7	—	1800	—	—
60 A 230 V cos φ = 0.7	—	—	1800	—
80 A 230 V cos φ = 0.7	—	—	—	1800

Other data				
	77.A3.x.xxx	77.B3.x.xxx	77.D3.x.xxx	77.F3.x.xxx
Critical rising voltage dv/dt without input control (gate open) @ T _j = 125 °C	500 V/μs	500 V/μs	500 V/μs	500 V/μs
I²t for fusing @ t _p = 10 ms	450 A ² s	1250 A ² s	2450 A ² s*	8190 A ² s**

Wiring diagrams

Single-phase connection
(77.01...802x)

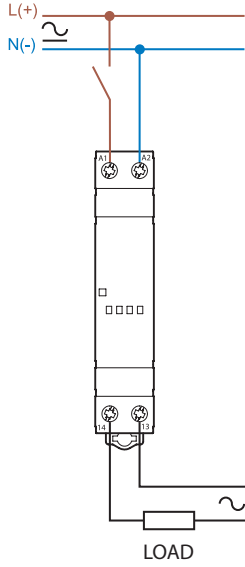

Single-phase connection DC
(77.01...9x2x)

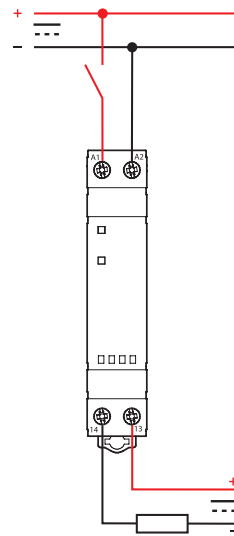

Single-phase connection
(77.11/77.21)

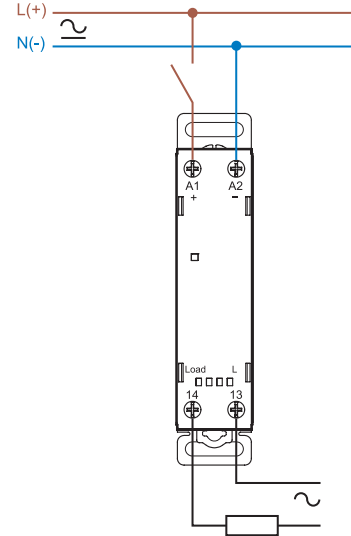

Single-phase connection
(77.31...805x)

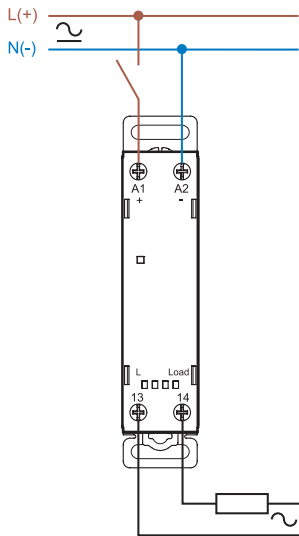

Single-phase connection
(77.31...807x)

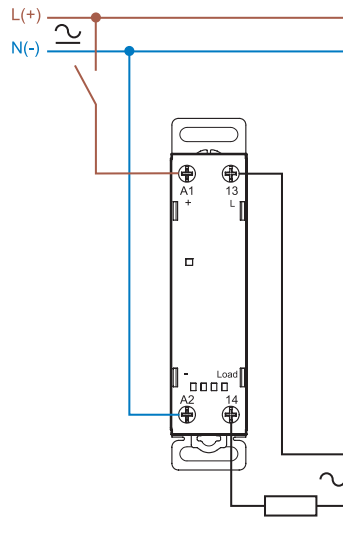

Example of three-phase connection
(with 3 x 77.01)

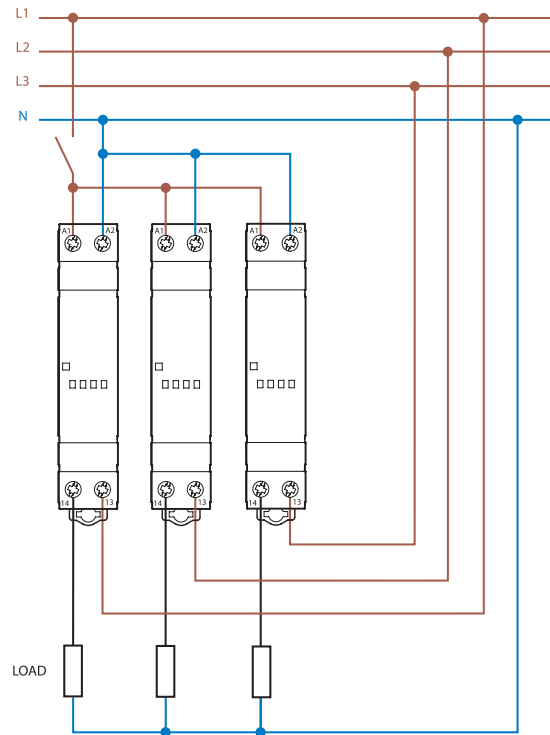

Note: this connection can be used with all 77 series types.

D

Wiring diagrams

Single-phase connection
(77.x1)

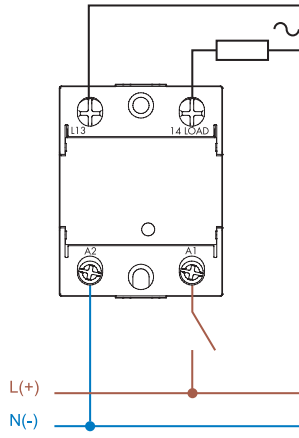

Dual phase connection
(77.x2)

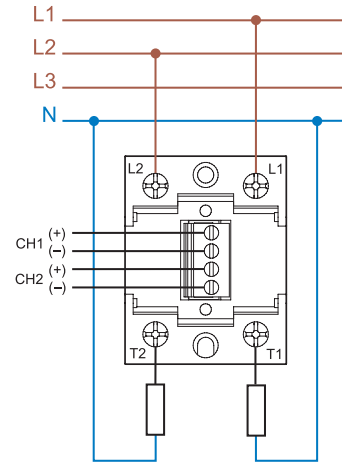

Three phase connection
(77.x3)

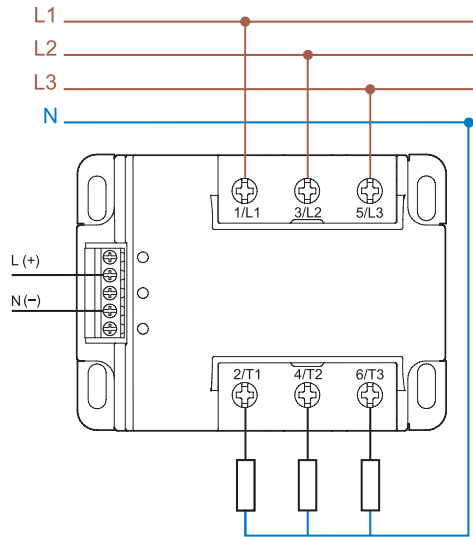

D

Outline drawings

Type 77.01
Box clamp

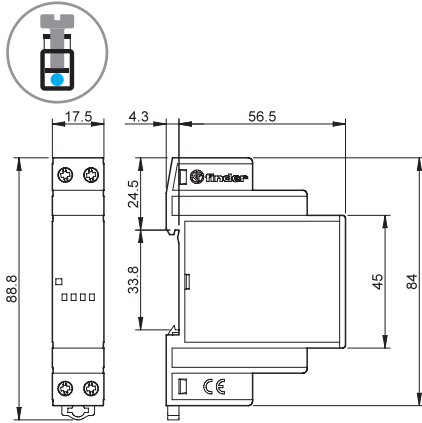

Types 77.11/21/31
Box clamp

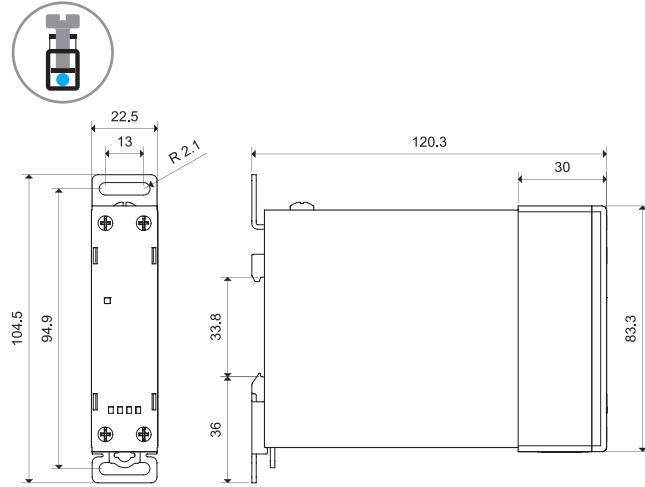

Type 77.01 DC
Box clamp

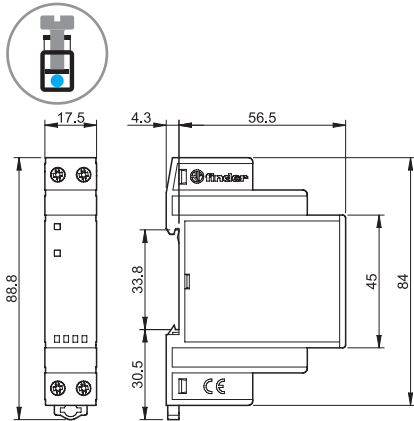

Type 77.x1
Screw terminal (plate clamp)

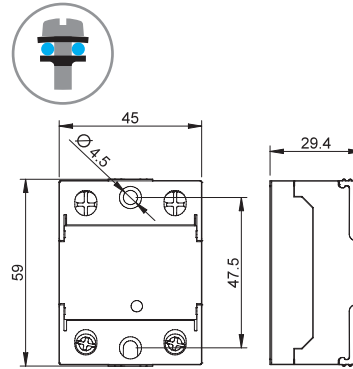

Type 77.x2
Screw terminal (plate clamp)

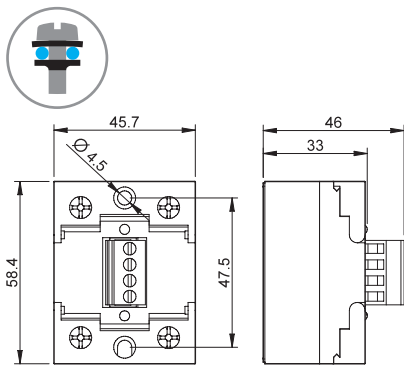

Type 77.x3
Screw terminal (plate clamp)

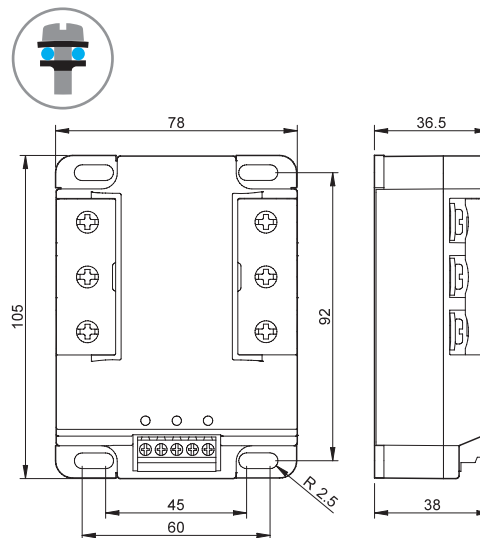

Accessories



020.01

Adaptor for panel mounting, plastic, 17.5 mm wide for 77.01 only

020.01

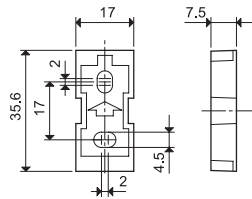

022.09

Separator for rail mounting, plastic, 9 mm wide

022.09

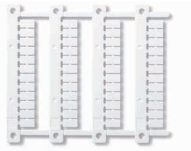
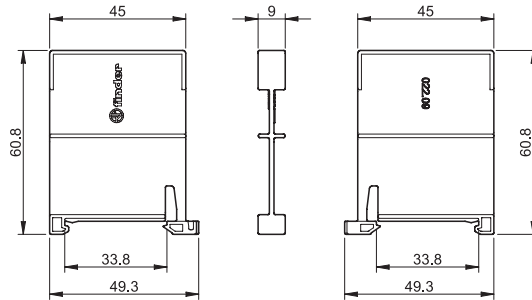

060.48

Sheet of marker tags (CEMBRE Thermal transfer printers) for all relays (48 tags), 6 x 12 mm

060.48

D

