



Southwire™

# TEMPORARY POWER CATALOG



**BUILT FOR DURABILITY.  
BUILT FOR RELIABILITY.  
BUILT FOR WORK.™**

SOUTHWIRE.COM

# OUR STORY

For over 60 years, Southwire has provided high quality electrical wire and cable to the commercial and industrial construction industries. Now, the name you trust provides durable, cutting-edge professional grade tools, designed with safety and productivity in mind. Look to Southwire® for solutions to all your electrical needs, from electrician's hand tools, meters, contractor equipment, temporary power, and extension cords.

## TEMPORARY POWER

Southwire has an extensive line of electrical safety product that ensures protection from dangerous current leakage that can cause electrical shock and electrical shock hazard. Our patented technologies enable you to protect people, property and equipment.

Southwire's electrical safety products are everyday electrical safety devices for use at home, the office, construction sites, refineries, mining, factories, portable equipment or wherever people use portable electrical equipment. The devices are required to be used throughout the world and we have products that are in accordance with the following standards:

- NEC – Article 590.6
  - OSHA standard for general industry 29 CFR 1910
  - OSHA standard for construction industry 29 CFR 1926.404
  - UL 943
  - cULus 1640
-



# TABLE OF CONTENTS

## TEMPORARY POWER PRODUCTS

- X-Treme Box™ 50 Amp ..... 5
- Mini X-Treme Box™ 20 Amp to 50 Amp ..... 6
- Barricade™ Power Distribution Boxes ..... 7
- Specialty Power Distribution Boxes..... 8
- 3-Phase Power Distribution Boxes ..... 9
- 3-Phase Power Distribution Carts ..... 10
- 3-Phase Transformer Power Stations ..... 12
- Portable Power Cords/Plugs/Ends/Adapters ..... 14
- 50-Amp Temporary Power Adapters..... 15
- Specification Grade Temporary Cords ..... 16
- Power Cords ..... 18
- Wiring Devices..... 19

## CABLE PROTECTION SYSTEMS

- Southwire® Cable Protection Systems ..... 24

# TEMPORARY POWER PRODUCTS

---

When you need power at your jobsite, go with the industry's leader in temporary power. Engineered utilizing the latest in GFCI technology, Southwire's iconic yellow temporary power boxes have been providing contractors, electricians, and engineers with the highest level of electrical safety for over 35 years. When combined with our specialty boxes and carts, Southwire product can be used to enable easy connections of temporary setups from any size power source to tools, heaters, chillers, de-humidifiers, welders, sound systems, lighting, and control systems.



# TEMPORARY POWER

## X-TREME BOX™ 50 AMP POWER DISTRIBUTION UNIT WITH GFCI PROTECTION



6506UGSX



6506UGSX STACKED











8706UGCX

This rugged equipment is designed to safely distribute temporary power in areas such as construction sites and other jobsite environments. cULus Listed for outdoor use and designed to stand up to the toughest workplace conditions. The 125V/20A receptacles on the unit are protected by individual GFCI's with "Power On" indicators and, high voltage shut off protection. They also provide open neutral and reverse phasing protection. Each unit has been carefully assembled to provide the ultimate in electrical safety as well as meeting current OSHA requirements.

The units use a 50A California Standard power inlet that distributes power to seven receptacles and a 50A California Standard pass-thru power outlet for daisy-chaining additional units. In addition to the six 125V/20A receptacles, each unit has one additional non-GFCI NEMA L6-30 turn-lock receptacle rated 250V/30A. Over current protection is provided by a full complement of circuit breakers located under an easy-access side panel. All units have a cULus Listing and NEMA Type 3R Rating (Outdoors with Light Rain)

### SPECIFICATIONS

PART#	BASE	CONSTRUCTION	POWER INLET / FEED-THRU	RECEPTACLES	OUTPUT CONFIGURATION	RECEPTACLES	OUTPUT CONFIGURATION
6506UGSX	Sled Base	Power Coated Steel	50A 125/250V Locking California-Style CS63 Inlet and Outlet	NEMA 5-20 125V 20A 2P3W 'T-Slot' single receptacles with dedicated GFCI protection	5-20 'U-Ground' x 6	1 x 250V 2P3W 30-Amp NEMA L6-30	L6-30 x 1
8706UGCX	Roll Cage			NEMA 5-20 125V 20A 2P3W 'T-Slot' duplex receptacles with dedicated GFCI protection			
6506UGSD	Sled Base			Heavy-Duty Stainless Steel		NEMA 5-20 125V 20A 2P3W 'T-Slot' single receptacles with dedicated GFCI	
8706UGCD	Roll Cage	NEMA L5-20 125V 20A 2P3W 'Twist-Lock' single receptacles with dedicated GFCI protection					
7506UGSX	Sled Base	Powder Coated Steel		NEMA L5-20 125V 20A 2P3W 'Twist-Lock' single receptacles with dedicated GFCI protection	6 x L5-20 'Twist-Lock'	1 x 250V 2P3W 30-Amp NEMA L6-30	L6-30 x 1
7706UGCX	Roll Cage			NEMA L5-20 125V 20A 2P3W 'Twist-Lock' single receptacles with dedicated GFCI protection			
6506TLSX	Classic - Legs	Heavy-Duty Stainless Steel		NEMA L5-20 125V 20A 2P3W 'Twist-Lock' single receptacles with dedicated GFCI protection		1 x 250V 2P3W 30-Amp NEMA L6-30	
8706TLCX	Rugged - Frame			NEMA L5-20 125V 20A 2P3W 'Twist-Lock' single receptacles with dedicated GFCI protection			
7506TLSX	Classic - Legs	Heavy-Duty Stainless Steel		NEMA L5-20 125V 20A 2P3W 'Twist-Lock' single receptacles with dedicated GFCI protection		1 x 250V 2P3W 30-Amp NEMA L6-30	
7706TLCX	Rugged - Fram			NEMA L5-20 125V 20A 2P3W 'Twist-Lock' single receptacles with dedicated GFCI protection			

Yellow is a standard color, other colors made to order with minimum quantities.



TEMP POWER | X-TREME BOX™

# TEMPORARY POWER

## MINI X-TREME BOX™ 20 AMP TO 50 AMP TEMPORARY POWER DISTRIBUTION UNITS WITH GFCI PROTECTION

6532UGM1



6508TLSX



6532UGMX



Southwire's Mini X-Treme Box™ and Mini-Centers provide a more compact and less costly work-site power distribution than our popular full size models. Used along with our restoration adapters, these units are ideal for disaster restoration work where the only available power is from range outlets, dryer outlets or smaller portable generators. Or, they can be used in any situation where a more compact, easier-to-handle unit is desired to safely expand and distribute power on jobsites.

- 14 Ga. Steel endures for years of use
- Heavy-duty, impact & flame-resistant enclosure
- GFCI Protection includes open neutral, reverse phasing, & 240V shut-off with indicator light
- Outdoor and Indoor-Rated Options allow application based choices without extra cost
- GFCI meets UL 943 requirements with 4-6 milliamp trip level, <25 milliseconds trip time
- 20-Amp, 30-Amp, and 50-Amp 125/250V 3 Pole 4 Wire



### PAIRS WITH

- 6606GUSF-254/256 for 3-Phase Power Distribution. *PG 9*
- 6212DC and 6220CC for 3-Phase Power Distribution. *PG 10*
- 50-Amp Temporary Power Cables for input power. *PG 14*
- 6606GUF-554/556 for Single-Phase Power Distribution. *PG 8*
- 6415 and 6410 cables for input power. *PG 17*
- 6606GUF-544/546 for Single-Phase Power Distribution. *PG 8*
- 6413 and 6411 cables for input power. *PG 17*

 **WE'VE GOT IT  
MADE IN AMERICA™**

 **CUSTOMIZATION  
AVAILABLE**

 **US LISTED**

PART #	BASE	RATING	POWER INPUT	RECEPTACLES	OUTPUT CONFIGURATION
6534UGSX	Sled Base	30A Type 3R Outdoor	L-14-30 Tail	4 x NEMA 5-20 GFCI Protected Duplex	 5-20 "U-Ground"
6508UGSX		50A Type 3R Outdoor	CS6365 Tail		
6522UGMX	Mini w. Feet	20A Type 1 Indoor	L14-20 Tail	4 x NEMA 5-20 GFCI Protected Duplex, split across 2 circuits	
6532UGMX		30A Type 1 Indoor	L14-30 Tail		
6532UGM1		30A Type 1 Indoor	L14-30 Inlet		
6534TLSX	Sled Base	30A Type 3R Outdoor	L14-30 Tail	4 x NEMA L5-20 GFCI Protected	 L5-20 "Twist-Lock"
6508TLSX		50A Type 3R Outdoor	CS6365 Tail		
6522TLMX	Mini w. Feet	20A Type 1 Indoor	L14-20 Tail	4 x NEMA L5-20 GFCI Protected, split across 2 circuits	
6532TLMX		30A Type 1 Indoor	L14-30 Tail		

# TEMPORARY POWER

## BARRICADE™ POWER DISTRIBUTION BOXES WALL MOUNTED 8000-SERIES

8806UGFX



8806TLBX



Engineered using the latest in GFCI Technology, and providing the user with the highest level of Electrical Safety, Southwire's newest line of wall-mounted Barricade Boxes is an innovation for the construction industry. With OSHA mandating that cords, cables, and hoses be removed from the floor, the Barricade Box gives the user a perfect solution while keeping the outdoor rating of the product. The box is UL Listed for Outdoor Use and required to mount off the floor away from water, dust, mud and other harmful environmental elements, with both 6-circuit and 8-circuit versions available, with or without rugged frame.

- Meets the current OSHA standards for Electrical Safety and can help meet their latest standard to reduce tripping hazards
- 14 Ga. Steel or Stainless-Steel Construction endures for years of use
- Heavy-duty, impact & flame-resistant enclosure
- Rugged, Wrap-Around Frame option adds extra durability
- GFCI Protection includes open neutral, reverse phasing, & 240V shut-off with indicator light
- GFCI meets UL 943 requirements with 4-6 milliamp trip level, <25 milliseconds trip time
- 50-Amp 125/250V 3 Pole 4 Wire







PAIRS WITH

- 6606GUSF-254/256 for 3-Phase Power Distribution. *PG 9*
- 6212DC and 6220CC for 3-Phase Power Distribution. *PG 10*
- 50-Amp Temporary Power Cables for input and output power. *PG 14*
- 1035 and 1030 cables for L6-30 receptacle. *PG 16*

 **WE'VE GOT IT  
MADE IN AMERICA™**

 **CUSTOMIZATION  
AVAILABLE**

 **US LISTED**

PART #	STRUCTURE	POWER INLET	FEED-THRU OUTLET	RECEPTACLES	OUTPUT CONFIGURATION	RECEPTACLES	OUTPUT CONFIGURATION
8806UGBX	Hanging Ears	 CS6375	 CS6369	"NEMA 5-20 125V 20A 2P3W 'T-Slot' single receptacles with dedicated GFCI protection"	 5-20 "U-Ground" x6 (8806) or x8 (8808)	1 x 250V 2P3W 30-Amp NEMA L6-30	 L6-30 x 1
8806UGFX	Frame						
8808UGBX	Hanging Ears						
8808UGFX	Frame						
8806TLBX	Hanging Ears			"NEMA L5-20 125V 20A 2P3W 'Twist-Lock' single receptacles with dedicated GFCI protection"	 L5-20 "Twist-Lock" x6 (8806) or x8 (8808)	1 x 250V 2P3W 30-Amp NEMA L6-30	 L6-30 x 1
8806TLFX	Frame						
8808TLBX	Hanging Ears						
8808TLFX	Frame						

BUILT FOR DURABILITY. BUILT FOR RELIABILITY. BUILT FOR WORK.™ | 7

TEMP POWER | POWER DISTRIBUTION BOXES

# TEMPORARY POWER

## SPECIALTY POWER DISTRIBUTION BOXES 4- OR 6-OUTLET 50-AMP RUGGED POWER DISTRIBUTION BOXES

6606GUF-554











- Powers additional Temporary Power Boxes, or plugs directly into Single-Phase Systems
- 14 Ga. Steel or Stainless-Steel Construction endures for years of use
- Heavy-duty, impact & flame-resistant enclosure
- 125/250V 3 Pole 4 Wire to 4- or 6- outlet configurations

**PAIRS WITH**

- 6606GUSF-254/256 for 3-Phase Power Distribution. *PG 9*
- 6212DC and 6220CC for 3-Phase Power Distribution. *PG 10*
- 50-Amp Temporary Power Cables for input and output power. *PG 14*
- Cables for output power. *PG 16-17*



TEMP POWER | POWER DISTRIBUTION BOXES

PART #	POWER INLET	FEED-THRU	RECEPTACLES	CONFIGURATION
6606GUF-524	 CS6375	CS6369	4 x 250V 2P3W 20-Amp NEMA L6-20	 L6-20 x 4
6606GUF-526		None	6 x 250V 2P3W 20-Amp NEMA L6-20	 L6-20 x 6
6606GUF-534		CS6369	4 x 250V 2P3W 30-Amp NEMA L6-30	 L6-30 x 4
6606GUF-536		None	6 x 250V 2P3W 30-Amp NEMA L6-30	 L6-30 x 6
6606GUF-544		CS6369	4 x 125/250V 2P3W 20-Amp NEMA L14-20	 L14-20 x 4
6606GUF-546		None	6 x 125/250V 2P3W 20-Amp NEMA L14-20	 L14-20 x 6
6606GUF-554		CS6369	4 x 125/250V 2P3W 30-Amp NEMA L14-30	 L14-30 x 4
6606GUF-556		None	6 x 125/250V 2P3W 30-Amp NEMA L14-30	 L14-30 x 6



# TEMPORARY POWER

## BOOSTER BOX, TEMPORARY POWER TRANSFORMER

6700



Southwire's Booster Box allows your temporary power run to be extended beyond the recommended 300-feet. Adding an approximate 15% voltage boost, the booster box prevents damage to tool and equipment, as well as circuit breaker nuisance caused by low voltage situations.

- Inlet: 50A 125/250V CS 6375
- Receptacle: 50A 125/250V CS 6369
- 12 kVA 130-degree Rise transformer
- Approximate 15% Voltage Boost



\*No NTRL Approval

CAT. NO.	POWER INLET	POWER OUTLET	DESCRIPTION
6700	CS6375	CS6369	1 x 12kVA Booster Transformer

## 3-PHASE POWER DISTRIBUTION BOXES

6606GUSF-256



Southwire's heavy duty rugged specialty boxes are made to enable easy connection of temporary power boxes to a larger power source, such as a generator or transformer. They can also be used for tools, heaters, chillers, de-humidifiers, welders, and any type of equipment up to 208V AC. All Southwire's Three-Phase Power boxes are UL 1640 Type 3R Outdoor-Rated, and may be custom configured to meet the needs of specific user applications.

- 14 Ga. Stainless-Steel Construction endures for years of use
- Heavy-duty, impact & flame-resistant enclosure
- Rugged, Wrap-Around Frame adds extra durability

PAIRS WITH

- 50-Amp Temporary Power Cables for output power. *PG 14*
- CAM-Type Power Distribution Boxes Cable Selections. *PG 18*



PART #	POWER INLET	RATING	WEIGHT
6606GUSF-254	Series 16 CAM-Type Devices	4 x CS6369 125/250V 50A 3P4W	4 x 6369
6606GUSF-256		6 x CS6369 125/250V 50A 3P4W	6 x 6369
6606GUSF-304		4 x L21-20 120/208V 20A 4P5W	4 x L21-20



TEMP POWER | POWER DISTRIBUTION BOXES

# TEMPORARY POWER

## 3-PHASE POWER DISTRIBUTION CARTS

6210DC



Our Distribution Panels are designed to act as the feeder to smaller temporary power boxes, or are wired for powering large equipment. Either a larger three phase generator or other source may power them. All of Southwire's Three-Phase Power panels are UL 1640 Type 3R Outdoor-Rated, and may be custom configured to meet the needs of specific user applications. Please contact us for any modifications required.

- 16 Ga. Stainless-Steel Construction endures for years of use
- Clear Breaker panel window allows instant visibility on circuit status
- Heavy-duty cart allows for compact storage yet fast mobility
- Lifting Rings allow for fast access to hook into a lift and relocate where it is needed
- Heavy-duty, impact & flame-resistant enclosure
- All 120/208V Product is Listed for use in the USA and Canada
- Up to 600-Amp, 480V UL Listed. 600V Configurations available
- Carts Rated at 3,000 lb Load

6220CC















 **WE'VE GOT IT  
MADE IN AMERICA™**

 **CUSTOMIZATION  
AVAILABLE**



# TEMPORARY POWER

PART #	RATING	POWER INPUT	RECEPTACLES	OUTPUT CONFIGURATION	RECEPTACLES	OUTPUT CONFIGURATION	RECEPTACLES	OUTPUT CONFIGURATION
6210DC				 5-20 'U-Ground' x 10	2 x 250V 2P3W 30-Amp NEMA L6-30	 L6-30 x 2	---	---
6211DC	120/208V 100-Amp	Direct Wire, 2/5 Type W, 15 Ft.	"NEMA 5-20 Duplex 125V 20A 2P3W 'T-Slot' receptacles with dedicated GFCI protection"		4 x 120/208V 4P5W 20-Amp L21-20	 L21-20 x 4	---	---
6212DC					4 x 125/250V 4P5W 50-Amp 6369	 6369 x 4	---	---
6220CC	120/208V 200-Amp	Series 16 CAM-Type Devices			6 x 125/250V 4P5W 50-Amp 6369	 6369 x 6	2 x 250V 2P3W 30-Amp NEMA L6-30	 L6-30 DWG x 2
6221CC						8 x 120/208V 4P5W 20-Amp L21-20	 L21-20 x 8	---
6240CC	120/208V 400-Amp	Series 16 CAM-Type Devices			6 x 120/208V 4P5W 60-Amp IEC 560R9W	560R9W x 6	---	---
6241CC						4 x 120/208V 4P5W 100-Amp IEC 560R9W	5100R9W x 4	---
992H3XX-1A	480V 100-Amp	Direct Wire, 2/4 Type W, 15 Ft.	6 x 480V 3P4W 20-Amp NEMA L16-20	 L16-20 x 6	---	---	---	---
992H3XX-1B	480V 100-Amp		6 x 480V 3P4W 30-Amp NEMA L16-30	 L16-30 x 6	---	---	---	---
992H3XX-1C	480V 100-Amp		4 x CS8169 480V 50A 3P4W	 8169 x 4	---	---	---	---
992H3XX-1D	480V 100-Amp		4 x 460RS2W 480V 60A 3P4W	460RS2W x 4	---	---	---	---
992H3XX-1E	480V 100-Amp		4 x 480V 60A 3P4W IEC 460R7W	460R7W x 4	---	---	---	---
992H3XX-A	480V 250-Amp	Series 16 CAM-Type Devices	6 x 460R7W 480V 60A 3P4W IEC60309	460R7W x 6	---	---	---	---
992H3XX-B	480V 250-Amp			460R7W x 6	Series 16 CAM-Type Devices (Feed-Thru)	---	---	---
992H3XX-C	480V 250-Amp		6 x NEMA L16-30	 L16-30 x 6	---	---	---	---
992H3XX-D	480V 250-Amp		6 x NEMA L16-20	 L16-20 x 6	---	---	---	---
992H3XX-E	480V 250-Amp		6 x CS8169 480V 50A 3P4W	 8169 x 6	---	---	---	---



TEMP POWER | POWER DISTRIBUTION BOXES

# TEMPORARY POWER

## 3-PHASE TRANSFORMER POWER STATIONS

6210PDC15-2



6210PDC45



Southwire's line of Transformer Power Stations combine all the features of the 3 Phase Power Distribution Panels with an on-board 480V or 600V Delta/Wye Transformer. These units allow an easy and quick connection of a portable power system to a higher voltage system, without having to purchase or rent an additional generator or power line. Southwire offers both 2-wheel and 4-wheel Power Carts that are designed to break down 3-phase 480V Delta power into, 208V 3 phase, 250V single phase, or 125V power. The power supply input may be a direct wire feed, 60A or 100A pin and sleeve, or a CAM-Type device. These are available in 100, 200 or 400-amp configurations. Most applications are 480V 3-Phase Delta service to 120/208V 3-Phase Wye Service, but many different options are available and may be custom configured to meet the needs of specific user applications.

### FEAUTURES & BENEFITS

- 16 Ga. Stainless-Steel Construction endures for years of use
- UL Listed Type 3R Outdoor Rating for up to 480V, 400-Amp
- Clear Breaker panel window allows instant visibility on circuit status
- Heavy-duty cart allows for compact storage yet fast mobility
- Lifting Rings allow for fast access to hook into a lift and relocate where it is needed
- Heavy-duty, impact & flame-resistant enclosure
- Up to 600-Amp, 600V UL Listed Configurations available. Built to CSA Standards with either 480 Volt or 600 Volt transformers upon request
- Carts Rated for 3,000 lb (2-wheel) and 10,000 lb (4-Wheel) lifting



TEMP POWER | POWER DISTRIBUTION BOXES

PART #	CART TYPE	TRANSFORMER TYPE	TRANSFORMER	PRIMARY DISCONNECT	PANEL # (FROM PAGE 11)	RECEPTACLES	OUTPUT CONFIGURATION	RECEPTACLES	OUTPUT CONFIGURATION
6210PDC15-2	2-Wheel	480V 3P4W Delta to 120/208V 4P5W Wye	15KVA	30A	6210	NEMA 5-20 Duplex 125V 20A 2P3W 'T-Slot' receptacles with dedicated GFCI protection	5-20 'U-Ground' x 10	2 x 250V 2P3W 30-Amp NEMA L6-30	L6-30 x 2
6212PDC15-2	2-Wheel				6212		5-20 'U-Ground' x 2	4 x 125/250V 4P5W 50-Amp 6369	6369 x 4
6210PDC15	4-Wheel				6210		5-20 'U-Ground' x 10	2 x 250V 2P3W 30-Amp NEMA L6-30	L6-30 x 2
6212PDC15	4-Wheel				6212		5-20 'U-Ground' x 2	4 x 125/250V 4P5W 50-Amp 6369	6369 x 4
6210PDC30-2	2-Wheel	30KVA	60A	6210		5-20 'U-Ground' x 10	2 x 250V 2P3W 30-Amp NEMA L6-30	L6-30 x 2	
6212PDC30-2	2-Wheel			6212		5-20 'U-Ground' x 2	4 x 125/250V 4P5W 50-Amp 6369	6369 x 4	

# TEMPORARY POWER

## 3-PHASE TRANSFORMER POWER STATIONS CONTINUED

PART #	CART TYPE	TRANSFORMER TYPE	TRANSFORMER	PRIMARY DISCONNECT	PANEL # (FROM PAGE 11)	RECEPTACLES	OUTPUT CONFIGURATION	RECEPTACLES	OUTPUT CONFIGURATION	RECEPTACLE 1	OUTPUT CONFIGURATION		
6210PDC30	4-Wheel	480V 3P4W Delta to 120/208V 4P5W Wye	30KVA	60A	6210	NEMA 5-20 Duplex 125V 20A 2P3W "T-Slot" receptacles with dedicated GFCI protection	5-20 'U-Ground' x 10	2 x 250V 2P3W 30-Amp NEMA L6-30	L6-30 x 2				
6212PDC30	4-Wheel				6212		5-20 'U-Ground' x 2	4 x 125/250V 4P5W 50-Amp 6369	6369 x 4				
6210PDC45-2	2-Wheel				45KVA		6210	5-20 'U-Ground' x 10	2 x 250V 2P3W 30-Amp NEMA L6-30	L6-30 x 2			
6212PDC45-2	2-Wheel						6212	5-20 'U-Ground' x 2	4 x 125/250V 4P5W 50-Amp 6369	6369 x 4			
6212PDC45	4-Wheel		6212				4 x 125/250V 4P5W 50-Amp 6369		6369 x 4				
6220PDC45	4-Wheel		6220				5-20 'U-Ground' x 2		6 x 125/250V 4P5W 50-Amp 6369	6369 x 6	2 x 250V 2P3W 30-Amp NEMA L6-30	L6-30 x 2	
6220PDC75	4-Wheel		75KVA				90A		6220	5-20 'U-Ground' x 2	6 x 125/250V 4P5W 50-Amp 6369	6369 x 6	2 x 250V 2P3W 30-Amp NEMA L6-30
6221PDC75	4-Wheel							6221	8 x 120/208V 4P5W 20-Amp L21-20	L21-20 x 8			
6240PDC150	4-Wheel				150KVA			200A	6240	6 x 120/208V 4P5W 60-Amp IEC 560R9W	560R9W x 6		
6241PDC150	4-Wheel		6241				4 x 120/208V 4P5W 100-Amp IEC 560R9W		5100R9W x 4				
6210PDC15-1	2-Wheel	480V 3P4W Delta to 125/250V 3P4W Single-Phase Dry-Type	15KVA	30A	6210	5-20 'U-Ground' x 10	2 x 250V 2P3W 30-Amp NEMA L6-30	L6-30 x 2					
6210PDC25-1	2-Wheel			60A	6210		2 x 250V 2P3W 30-Amp NEMA L6-30	L6-30 x 2					
6212PDC25-1	2-Wheel			6212	5-20 'U-Ground' x 2		4 x 125/250V 4P5W 50-Amp 6369	6369 x 4					
6210PDC15-1E	2-Wheel	480V 3P4W Delta to 125/250V 3P4W Single Phase NEMA 4X Encapsulated	15KVA	30A	6210	5-20 'U-Ground' x 10	2 x 250V 2P3W 30-Amp NEMA L6-30	L6-30 x 2					
6210PDC25-1E	2-Wheel			60A	6210		2 x 250V 2P3W 30-Amp NEMA L6-30	L6-30 x 2					
6212PDC25-1E	2-Wheel			6212	5-20 'U-Ground' x 2		4 x 125/250V 4P5W 50-Amp 6369	6369 x 4					

TEMP POWER | POWER DISTRIBUTION BOXES

# TEMPORARY POWER

## PORTABLE POWER CORDS & REPLACEMENT PLUGS/ENDS/ADAPTERS

19180008



Rugged temporary power cords for use with the X-Treme Box™ to handle 50A 3-Pole/4-Wire 125/250v AC; safe appliance extension cords; cords for use in disaster recovery, restoration, renovation or maintenance projects requiring temporary, portable power.

### FEAUTES & BENEFITS

- 125/250V | 50A | 3 Poles | 4 Wires

LIV18240008



18340008



19190008







19380008



19390008



All Cables below use 125/250V 50-Amp 3 Pole 4 Wire CS63-Series devices

PART#	CONNECTOR NEMA	LENGTH	GAUGE / NO. OF CONDUCTORS	TYPE	JACKET	DEVICE GRADE		
6410S	 CS63 Series	10	6/4	SEOW	Rubber Alloy	Commercial		
6410M			6/4	SOW	Rubber	Industrial		
6410MC 			6/3-8/1	SEOW	Rubber Alloy, CSA Certified Components	Commercial		
6425S		25	25	6/3-8/1	SEOW	Rubber Alloy	Commercial	
6425M				6/4	SOW	Rubber	Industrial	
19370008 				6/3-8/1	SEOW	Elastomer CSA Certified, Industrial Components	Commercial	
19180008		50	50	6/3-8/1	STOW/SEOW	Elastomer	Commercial	
6450M				6/4	SOW	Rubber	Industrial	
19380008 				6/3-8/1	SEOW	Elastomer CSA Certified, Industrial Components	Commercial	
19190008		100	100	6/3-8/1	STOW/SEOW	Rubber Alloy	Commercial	
6400M					6/4	SOW	Rubber	Industrial
19390008 					6/3-8/1	SEOW	Elastomer CSA Certified, Industrial Components	Commercial

# TEMPORARY POWER

## 50-AMP TEMPORARY POWER ADAPTERS

19200008















 **WE'VE GOT IT  
MADE IN AMERICA™**

 **CUSTOMIZATION  
AVAILABLE**

Southwire offers the broadest range of temporary power cords available on the market. We have the ability to assemble power cords with any configuration of wiring device, size, and length of cord. The power cords are used as a transition from your primary power source (such as: transformer, generator, facility power) into our Single Phase and 3-Phase Power Distribution Units. The cords can also be personalized with your name and logo through our custom cord labeling procedure.

- Heavy-Duty Rubber, Industrial Duty, Type S00W cable for years of usage and zero compliance issues
- Cordsets have federal specification (WC596) grade plug and connectors
- Excellent resistance to oil and moisture
- High flexibility, excellent abrasion resistance

PART #	MALE DEVICE	MALE DEVICE DWG	FEMALE DEVICE	FEMALE DEVICE DWG	LENGTH	GAUGE / # OF CONDUCTORS	TYPE
19200008	6365 125/250V 3P4W 50-Amp	 CS6365	6364 125/250V 3P4W 50-Amp	 2 x CS6364	3	6/4	S00W
18540008	14-30 125/250V 3P4W 30-Amp	 L14-30	L14-30 125/250V 3P4W 30-Amp	 L14-30	10	6/4	
LIV18240008	14-30 125/250V 3P4W 30-Amp		6364 125/250V 3P4W 50-Amp	 CS6364	10	6/4	
18640008	14-50 125/250V 3P4W 50-Amp	 L14-50	L14-30 125/250V 3P4W 30-Amp	 L14-30	10	6/4	
18440008	L14-30 125/250V 3P4W 30-Amp	 L14-30	6364 125/250V 3P4W 50-Amp	 CS6364	10	6/4	
18340008	14-50 125/250V 3P4W 50-Amp	 L14-50	6364 125/250V 3P4W 50-Amp		10	6/4	
100723	6365 125/250V 3P4W 50-Amp	 CS6365	14-50 125/250V 3P4W 50-Amp	 L14-50	2	6/4	
SR50	3 Ft #6 AWG WIRE		6364 125/250V 3P4W 50-Amp	 CS6369	2	6/4	







**TEMP POWER** | POWER CORDS

# TEMPORARY POWER

## SPECIFICATION GRADE TEMPORARY CORDS



 **WE'VE GOT IT  
MADE IN AMERICA™**







PART#	CONNECTOR NEMA	LENGTH	VOLTAGE	AMPS	POLES	WIRES	GAUGE / NO. OF CONDUCTORS	TYPE	JACKET	
3105	 5-15	50	125	15	2	3	10/3	SOW STW Yellow	Rubber	
3101		100								
3205		50								
3201		100								
1235	 L5-20	50		20	3	12/3				
1230		100								
1005	 L5-30	50		30	2	3	10/3			
1001		100								
1225	 L6-20	50		250	20	2	3			12/3
1220		100								
1035		50								
1030	 L6-30	100	30	2	3	10/3				
1381		25	125/250V	20	3	4	10/4			
6416	50	STW Yellow								
6411	100	SOW								
6413	50									
6412	100									
1493	 L14-30	25		30	10/4	STW Yellow				
6415		50								
6410		100								
1250	 L21-20	50		120/208	20	4	5	12/5	SOW	
1251		100								





TEMP POWER | SPEC GRADE



# TEMPORARY POWER

## SPECIFICATION GRADE TEMPORARY CORDS CONTINUED

PART#	CONNECTOR NEMA	LENGTH	VOLTAGE	AMPS	POLES	WIRES	GAUGE / NO. OF CONDUCTORS	TYPE	JACKET					
1050	 L21-30	50	250	30	3	4	10/5	SOW	Rubber					
1051		100												
1245	 L15-20	50		20			12/4							
1240		100												
1045	 L15-30	50		30			10/4							
1040		100												
1246	 L16-20	50		20			12/4							
1241		100												
1046	 L16-30	50		30			480			10/4				
1041		100												
19178806	 6-50	25		250V			50			2	3	8/3	STW	Blue - Thermoplastic
19228806		50												
1034	 L6-30	3	250V	30	2	3	10/4	--	--					
1043														

PART #	MALE DEVICE	MALE DEVICE DWG	FEMALE DEVICE	FEMALE DEVICE DWG	LENGTH	GAUGE/# OF CONDUCTORS	TYPE
1010	L14-20 125/250V 3P4W 20-Amp	 L14-20 x 1	4 x 125V 20A 2P3W 'T-Slot' Receptacles	*5-20	4	12/4	S00W
1011					50		
1012					100		
1034	L6-30 250V 2P3W 30-Amp	 1 x L6-30	L6-30 250V 2P3W 30-Amp	2 x L6-30	3	10/3	S00W
1043	L14-30 125/250V 3P4W 30-Amp	 1 x L14-30	L14-30 125/250V 3P4W 30-Amp	2 x L14-30	3	10/4	S00W
100475	8165 480V 3P4W 50-Amp	 8165	8164 480V 3P4W 50-Amp	2 x 8164	3	8/4	W

TEMP POWER | SPEC GRADE

# TEMPORARY POWER

## CALIFORNIA STYLE AND IEC60309 CONFIGURATIONS

6647



8100



**WE'VE GOT IT  
MADE IN AMERICA™**



**CUSTOMIZATION  
AVAILABLE**

PART#	DEVICE	LENGTH	VOLTAGE	AMPS, POLES, WIRES	GAUGE AND CABLE TYPE
8105	CS81 Series	50	480	50A 3P4W	6/4 Type S00W Rubber
8100		100			
8305	CS83 Series	50	250		
8300		100			
6640	460P12W	50ft	125/250	60A 3P4W	8/4 Type W Rubber
6640		100ft			
6646	4100P12W	50ft		100A 3P4W	4/4 Type W Rubber
6641		100ft			
6647	460P7W	50ft	480	60A 3P4W	8/4 Type W Rubber
6642		100ft			
6648	4100P7W	50ft		100A 3P4W	4/4 Type W Rubber
6643		100ft			
6655	560P9W	50ft	120/208	60A 4P5W	6/5 Type W Rubber
6601		100ft			
6650	5100P9W	50ft		100A 4P5W	2/5 Type W Rubber
6600		100ft			

## CAM-TYPE CONFIGURATIONS



	BK Black		BR Brown
	BU Blue		Y Yellow
	R Red		O Orange
	W White		GR Green

PART#	TYPE	RATING	LENGTH	GAUGE	DESCRIPTION	JACKET
6120	SC	200 AMP	100ft.	2/0	Extension	Rubber
6120	W					
6125	SC		50ft.			
6125	W					
61225	SC		25ft.		Female Tail	
61225	W					
6121P	SC		10ft.			
6121P	W					
6140	SC	400 AMP	100ft.	4/0	Extension	
6140	W					
6145	SC		50ft.			
6145	W					
61425	SC		25ft.		Female Tail	
61425	W					
6141P	SC		10ft.			
6141P	W					

To Order CAM-TYPE Cords: "Cat. No." + "Jacket" + "Color". Example: 6120WBK

# TEMPORARY POWER

## WIRING DEVICES

59840000



59850000







Southwire is committed to offering you the widest range of wiring devices on the market. Our devices range from 15-amp up to 400-amps in a variety of straight blade, locking, pin & sleeve, and CAM-Type configurations. This range of devices is manufactured for economy grade, commercial grade, and industrial grade applications. If you do not see the device or configuration needed, simply contact us at [SOUTHWIRE.COM](http://SOUTHWIRE.COM).

CS6375



18910000









CONNECTOR NEMA	PART#	MANUFACTURER	VOLTAGE	AMPS	DEVICE TYPE	GRADE
 1-15	9754NS	Bryant	125	15	Plug	Commercial
	9755NS	Bryant	125	15	Connector	
 5-15	59840000	Southwire	125	15	Plug	Commercial
	59900000	Woodhead	125	15		Industrial
	5266MA	Marinco	125	15		Marine
	59820000	Bryant	125	15	Connector	Commercial
	59920000	Woodhead	125	15		Industrial
	59850000	Southwire	125	15		Marine
	59910000	Woodhead	125	15		Commercial
	59830000	Bryant	125	15		Industrial
	5269MA	Marinco	125	15		Marine
	59930000	Woodhead	125	15		Commercial
 L5-15	4721N	Bryant	125	15	Plug	Industrial
	4720MA	Marinco	125	15	Connector	
	4732N	Bryant	125	15		
	4729MA	Marinco	125	15	Receptacle	
	4700	Bryant	125	15		
 5-20	5366N	Bryant	125	20	Plug	Industrial
	5366MA	Marinco	125	20	Connector	
	5369N	Bryant	125	20		
	5369MA	Marinco	125	20	Receptacle	
	18920000	Leviton or Bryant	125	20		

TEMP POWER | WIRING DEVICES

# TEMPORARY POWER







## WIRING DEVICES

CONNECTOR NEMA	PART#	MANUFACTURER	VOLTAGE	AMPS	GRADE	DEVICE TYPE
 L5-20	205P	Marinco	125	20	Plug	Industrial
	59860000	Bryant	125	20		
	26W47	Woodhead	125	20	Connector	Marine
	59870000	Bryant	125	20		Industrial
	205C	Marinco	125	20		
	27W47	Woodhead	125	20	Receptacle	Marine
	L520R	Southwire	125	20		Industrial
	18910000	Marinco	125	20		
 L5-30	305P	Marinco	125	30	Plug	Industrial
	59620000	Hubbell	125	30	Industrial	
	305C	Marinco	125	30	Connector	
	59630000	Bryant	125	30		
	305R	Marinco	125	30	Receptacle	
 L6-20	70620NP	Bryant	250	20	Plug	Industrial
	206P	Marinco	250	20		
	70620NC	Bryant	250	20	Connector	
	206C	Marinco	250	20		
	206R	Marinco	250	20	Receptacle	
 L14-20	714205NP	Bryant	125/250	20	Plug	Industrial
	2014P	Marinco	125/250	20		
	71420NC	Bryant	125/250	20	Connector	
	2014P	Marinco	125/250	20		
	2014R	Marinco	125/250	20	Receptacle	
 L15-20	2015P	Marinco	250	20	Plug	Industrial
	2015C	Marinco	250	20	Connector	
	2015R	Marinco	250	20	Receptacle	
 L21-20	2021P	Marinco	120/208	20	Plug	Industrial
	2021C	Marinco	120/208	20	Connector	
	2021R	Marinco	120/208	20	Receptacle	
 L16-20	2016P	Marinco	480	20	Plug	Industrial
	2016C	Marinco	480	20	Connector	
	2016R	Marinco	480	20	Receptacle	

TEMP POWER | WIRING DEVICES

# TEMPORARY POWER



## WIRING DEVICES

CONNECTOR NEMA	PART#	MANUFACTURER	VOLTAGE	AMPS	GRADE	DEVICE TYPE
 L6-30	306P	Marinco	250	30	Plug	Industrial
	59640000	Bryant	250	30	Plug	Industrial
	53650000	Bryant	250	30	Connector	Industrial
	306C	Marinco	250	30	Connector	Industrial
	L630R	Southwire	250	30	Receptacle	Industrial
	306R	Marinco	250	30	Receptacle	Industrial
 L14-30	71430NP	Bryant	125/250	30	Plug	Industrial
	3014P	Marinco	125/250	30	Plug	Industrial
	71430NC	Bryant	125/250	30	Connector	Industrial
	3014C	Marinco	125/250	30	Connector	Industrial
	3014R	Marinco	125/250	30	Receptacle	Industrial
 14-30	9432ANP	Bryant	125/250	30	Industrial	Right-Angle Plug
 L15-30	3015P	Marinco	250	30	Plug	Industrial
	3015C	Marinco	250	30	Connector	Industrial
	3015R	Marinco	250	30	Receptacle	Industrial
 L21-30	3021P	Marinco	120/208	30	Plug	Industrial
	3021C	Marinco	120/208	30	Connector	Industrial
	3021R	Marinco	120/208	30	Receptacle	Industrial
 L16-30	3016P	Marinco	480	30	Plug	Industrial
	3016C	Marinco	480	30	Connector	Industrial
	3016R	Marinco	480	30	Receptacle	Industrial
 14-50	9452ANP	Bryant	125/250	50	Right-Angle Plug	Industrial

TEMP POWER | WIRING DEVICES

# TEMPORARY POWER

## WIRING DEVICES

CONNECTOR NEMA	PART#	MANUFACTURER	VOLTAGE	AMPS	GRADE	DEVICE TYPE
 CS63 Series	59740000	Bryant	125/250	50	Commerical	Plug
	6365M	Marinco	125/250	50		
	59580000	Hubbell	125/250	50	Industrial	Connector
	59750000	Bryant	125/250	50	Commerical	
	6364M	Marinco	125/250	50		
	59590000	Hubbell	125/250	50	Industrial	
	6375H	Bryant	125/250	50		Receptacle
	18940000	Bryant	125/250	50		
 CS83 Series	8365LV	Leviton	250	50	Plug	Commercial
	8364LV	Leviton	250	50	Connector	
 CS81 Series	8165LV	Leviton	480	50	Plug	Commercial
	8164LV	Leviton	480	50	Connector	

# CABLE PROTECTION SYSTEMS

---

Southwire's cable protection systems are the perfect accessory to ensuring the longevity of your investment and the safety of your jobsite. With both slim and tall options, and medium and heavy duty options, there is a ramp to match most every temporary power need on a jobsite.



# CABLE PROTECTION

## SOUTHWIRE® CABLE PROTECTION SYSTEMS



A complete cable protection system. Perfect for any application where cables are in harms way. Eliminates downtime, costly repairs and reduces liability.

### APPLICATIONS FOR

- Entertainment Industry
- Institutions and Municipalities
- Industrial, Construction & Utilities



3 Channel Linear  
31205-1

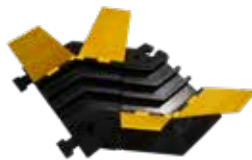

3 Channel Right & Left  
31206-1, 31207-1



3 Channel End Cap  
31208-1

PART #	DESCRIPTION	CHAN- NEL QTY	LENGTH	WIDTH	HEIGHT	WEIGHT	CHANNEL SIZE	RATING	BASE	LID
3110	3 Ft. 5-Channel Heavy Duty	5	36	20	2.31	25	1.35	40,000 Lbs per Axle	Thermoplastic	
3115	Set of Ends for PN# 3115	5	7.5 & 5.25	20	2.31	3.5	1.35	40,000 Lbs per Axle		
3111	3 Ft. 5-Channel Medium Duty	5	36	17.5	1.95	18	1.35	20,000 Lbs per Axle		
3116	Set of Ends for PN# 3111	5	4.75	17.5	1.95	2.7	1.35	20,000 Lbs per Axle	Rubber	EVA Plastic
31200-1	3 Ft. 5-Channel Heavy Duty	5	35.4	23.6	2.95	60	1.96 x 1.38	42,000 Lbs per Axle		
31201-1	Left Turn for PN# 31200-1	5	23.6	24.4	2.95	25	1.96 x 1.38	42,000 Lbs per Axle		
31202-1	Right Turn for PN# 31200-1	5	23.6	24.4	2.95	25	1.96 x 1.38	42,000 Lbs per Axle		
31203-1	Set of Ends for PN# 31200-1	5	7.8	23.6	2.95	18	1.96 x 1.38	42,000 Lbs per Axle		
31205-1	3 Ft. 3-Channel Heavy Duty	3	35.4	23.6	2.95	60	1.96 x 2.09	42,000 Lbs per Axle		
31206-1	Left Turn for PN# 31205-1	3	23.6	24.4	2.95	25	1.96 x 2.09	42,000 Lbs per Axle		
31207-1	Right Turn for PN# 31205-1	3	23.6	24.4	2.95	25	1.96 x 2.09	42,000 Lbs per Axle		
31208-1	Set of Ends for PN# 31205-1	3	7.8	23.6	2.95	18	1.96 x 2.09	42,000 Lbs per Axle		

\* BLACK JACKET HAS ONE FEMALE CONNECTOR AND THREE MALE CONNECTORS.



# OSHA SPECIFICATIONS

## DEFINITIONS & STANDARDS

### UL STANDARDS

UL Listed products are used in applications where the product is not an integral part of the manufactured system. UL Listed wire and cable products are intended for use within residential, commercial or industrial buildings.

### OSHA REGULATIONS

OSHA's scope of regulation covers three major business areas; the Construction Industry, the Maritime Industry and a third category, General Industry, which covers most other business enterprises except for those in mining and agriculture which are overseen by other government agencies. OSHA's regulations are Federal Law and are contained in the U.S. Government's Code of Federal Regulations (CFR). Violations of OSHA regulations can subject companies to legal action and fines.

### NEC (NATIONAL ELECTRICAL CODE) STANDARDS

The National Electrical Code (NEC®) requires use of listed products to meet the requirements of various "Articles" within the code.

## OSHA REGULATIONS

### GROUND FAULT PROTECTION

29CFR1910.304(b)(3)(ii)(A) All 125-volt, single-phase, 15-, 20-, and 30-ampere receptacle outlets that are not part of the permanent wiring of the building or structure and that are in use by personnel shall have ground-fault circuit-interrupter protection for personnel.

Note 1 to paragraph (b)(3)(ii)(A) of this section: A cord connector on an extension cord set is considered to be a receptacle outlet if the cord set is used for temporary electric power.

Note 2 to paragraph (b)(3)(ii)(A) of this section: Cord sets and devices incorporating the required ground-fault circuit-interrupter that are connected to the receptacle closest to the source of power are acceptable forms of protection.

29CFR1910.304(b)(3)(ii)(B) Receptacles other than 125 volt, single-phase, 15-, 20-, and 30-ampere receptacles that are not part of the permanent wiring of the building or structure and that are in use by personnel shall have ground-fault circuit-interrupter protection for personnel.

29CFR1910.304(b)(3)(ii)(C) Where the ground-fault circuit-interrupter protection required by paragraph (b)(3)(ii)(B) of this section is not available for receptacles other than 125-volt, single-phase, 15-, 20-, and 30-ampere, the employer shall establish and implement an assured equipment grounding conductor program covering cord sets, receptacles that are not a part of the building or structure, and equipment connected by cord and plug that are available for use or used by employees on those receptacles. This program shall comply with the following requirements (2 pages...)

1926.404(b)(ii) Ground-fault circuit interrupters. All 120-volt, single-phase, 15- and 20-ampere receptacle outlets on construction sites, which are not a part of the permanent wiring of the building or structure and which are in use by employees, shall have approved ground-fault circuit interrupters for personnel protection. Receptacles on a two-wire, single-phase portable or vehicle-mounted generator rated not more than 5kW, where the circuit conductors of the generator are insulated from the generator frame and all other grounded surfaces, need not be protected with ground-fault circuit interrupters.

### CORD PROTECTION

29CFR1910.304(b)(1) Examination. Electric equipment shall be free from recognized hazards that are likely to cause death or serious physical harm to employees. Safety of equipment shall be determined using the following considerations:

(viii) Other factors that contribute to the practical safeguarding of persons using or likely to come in contact with the equipment.

(7) Mechanical execution of work. Electric equipment shall be installed in a neat and workmanlike manner. 29CFR1910.305(a)(2)(x) Flexible cords and cables shall be protected from accidental damage, as might be caused, for example, by sharp corners, projections, and doorways or other pinch points. 29CFR1910.305(a)(2)(xi) Cable assemblies and flexible cords and cables shall be supported in place at intervals that ensure that they will be protected from physical damage. Support shall be in the form of staples, cables ties, straps, or similar type fittings installed so as not to cause damage.

1926.403 (b)(1) the employer shall ensure that electrical equipment is free from recognized hazards that are likely to cause death or serious physical harm to employees. Safety equipment shall be determined on the basis of the following considerations:

(vii) Other factors which contribute to the practical safeguarding of employees using or likely to come in contact with the equipment.

29CFR1926.405(a)(2)(ii)(B) Branch circuits shall originate in a power outlet or panelboard. Conductors shall be run as multi-conductor cord or cable assemblies or open conductors, or shall be run in raceways. All conductors shall be protected by over-current devices at their ampacity. Runs of open conductors shall be located where the conductors will not be subject to physical damage, and the conductors shall be fastened at intervals not exceeding 10 feet (3.05 m). No branch-circuit conductors shall be laid on the floor. Each branch circuit that supplies receptacles or fixed equipment shall contain a separate equipment grounding conductor if the branch circuit is run as open conductors.

29CFR1926.416(e)(1) Worn or frayed electric cords or cables shall not be used.

# NOTES

---

---

---

---

---

---

---

---

---

---

---

---

---

---

---

---

---

---

---

---

---

---

---

---

---

# NOTES





**Southwire™**

# TEMPORARY POWER CATALOG

## GET SOCIAL WITH US:



**/SOUTHWIRETOOLS**  
**/SOUTHWIRETOOLSLATINO**



**@SOUTHWIRETOOLS**



**@SOUTHWIRETOOLS**



**SOUTHWIRETOOLS**

**SOUTHWIRE.COM | 1-855-SWTOOLS**

All Trademarks or Registered Trademarks (TM/®) are owned or licensed by Southwire Company.  
Any other TM/® - Trademark or Registered Trademark of Southwire Company.